

صحة من الامم

NATIONAL FACTORY FOR AIR CONDITIONERS

Gibson They Last...

LOCALLY MANUFACTURED

Air Sweep

FIVE YEARS WARRANTY

RIYADH 4039255
JEDDAH 4039264
DAMMAM 4039264
IN NEW OFFICE DAMMAM 4039264
TEL: 201164 (ALGESA)

weekend edition

ARABIA'S FIRST ENGLISH LANGUAGE DAILY

Arab news

Publishers: saudi research and marketing company

THURSDAY-FRIDAY, JANUARY 15-16, 1981 RABI AL-AWAL 9-10, 1401 A.H.

ROLACO

Cement - Steel Equipment Contracting

TEL: JEDDAH 6654108-6604701
DAMMAM 8323888 RIYADH 4767236

Bill clears way to free 52 hostages

TEHRAN, Jan. 14 (AP) — Iran's parliament approved Wednesday one emergency bill aimed at clearing the way for release of the 52 American hostages and Iran's chief negotiator said, "we are going to release the hostages in the coming two or three days or a like a try them."

But parliament adjourned until Sunday without acting on another measure proposed by the Iranian government, which indicated it was seeking to meet a Friday deadline set by the Carter administration for reaching an agreement before President Jimmy Carter leaves office.

Meanwhile, the U.S. State Department interpreted latest moves in Tehran Wednesday as possibly a positive sign and a "step in the right direction" but denied that any agreement had been reached conditions for the hostages' release.

Department spokesman John Trattner greeted the news of the Iranian parliament's acceptance of arbitration in legal and financial issues with the United States with caution. He described the bill as a step in the right direction but called for patience as there could still be major snags.

Behzad Nabavi, Iran's chief negotiator in the 14-month hostage crisis, mentioned decisive action on the hostages in two or three days in what was seen by observers as an effort to push parliament into act on both emergency measures.

Later in the morning, a spokesman for the Majlis (parliament) told the Associated Press in Beirut by telephone that the government "will decide on the future of the American hostages" Thursday or Friday. He refused to amplify his remark.

In Algiers, an Algerian source said Wednesday Algeria had not yet made contingency plans for the hostages to transit through here on their eventual release. "We do not consider the situation has yet reached the stage where we need to make such plans," said the official, who declined to be named.

The official indicated, without saying so precisely, that Algeria had not yet officially been asked to receive the hostages. But he said he felt that if they did finally come to Algeria, it would only be to change planes en route to U.S. facilities in Wiesbaden, West Germany. "We might be asked to pick them up in Tehran and bring them here, and they would just get off one plane and on to another," the official said, while stressing he was speaking hypothetically.

Meanwhile, Swiss authorities issued an attachment order on a villa in St. Moritz owned by the family of the late Shah of Iran. The order apparently was taken at the initiative of Iran's lawyers in Switzerland, but it was not known if the action was directly connected with negotiations to free the hostages.

Tehran radio reported in a commentary on the situation that Carter was "forced to deposit 70 per cent of Iranian assets in U.S. banks with the Algerian national bank." The report did not elaborate and it was not clear if the commentator was outlining terms for an agreement or part of an effort to prepare Iranian public opinion for an accord.

Dollar drifts lower

LONDON, Jan. 14 (AP) — The dollar drifted slightly lower Wednesday while gold prices were little changed. Gold traded at \$563.50 a troy ounce in London mid-morning, down from \$564.25 late Tuesday. In Zurich the metal traded at a medium \$564.50 an ounce, unchanged.

In Hong Kong, gold closed at \$565.71 down 2.94. The metal finished at \$562 in New York late Tuesday. Silver was quoted in London at \$15.15 an ounce, up from 14.95. The British pound was worth \$2.3965 (2.3880).

In Tokyo, the dollar closed at 203.30 yen from 204.65 Tuesday. In European trading later in the day, the dollar was worth 203.25 yen.



LET'S START: Secretary of State-designate Gen. Alexander Haig gives a short salute at the start of the fourth day of confirmation hearings before the Senate Foreign Relations Committee Tuesday on Capitol Hill.

Libyan minister quits OAU summit talks

LOME, Jan. 14 (Agencies) — Libya's delegate Wednesday walked out of an African summit conference on ways of dealing with a proposed merger between Libya and Chad, saying that Egypt and some other countries should not be represented. Foreign Minister Ali Abdul-Salam Triki, representing Libyan leader Muammar Qaddafi at the meeting, left the private session within an hour of its start.

He told reporters he could not accept the presence of "... Egipt, Sudan, and of other unidentified countries." "Their presence is unacceptable. Libya will not sit at the meeting as long as they are here," he said angrily. The meeting was studying how to call on Libya to withdraw its forces from Chad, conference sources said.

Eleven heads of state and two foreign ministers are taking part in the talks called by the chairman of the Organization of African Unity (OAU), Siaka Stevens of Sierra Leone.

Several African nations have attacked the proposed merger to which Chad President

Goukouni Oueddei agreed during a visit to Tripoli last week. And informed sources in Lome said there was increasing African condemnation of the Libyan initiative. Virtually every west African state, with the exception of Marxist Benin, has shown concern about Libya's intentions in the area.

Meanwhile, the Soviet Union accused France Wednesday of using the plan for a union of Libya and Chad as a "pretext" for increasing its military presence in Africa. The Soviet Communist Party newspaper *Pravda* said in a commentary that France is "concerned" about Chad's attempts "to get rid of neo-colonialist patronage."

A Washington report said U.S. defense officials believe that Libyan forces in Chad will quickly become engulfed in a renewed civil war and will eventually be driven out of the former French colony. The officials described Libya as expansionist, but said they doubted that the Libyans would be able to repeat their Chad intervention elsewhere in the region.

Prepared to keep troops in Lebanon

Syria ready to face Israeli threat

BEIRUT, Jan. 14 (R) — Syrian Prime Minister Abdul Rauf Kasbi has said his government is prepared to keep thousands of troops in Lebanon to face the threat of Israeli expansionism. Arab diplomatic sources said Kasbi's remarks, in an interview with the Lebanese magazine *As-Sayyid*, indicated a significant change in Syria's view of its military presence here.

More than 20,000 Syrian troops have been deployed in Lebanon as Arab Deterrent Force (ADF) since they intervened to end the country's 1975-76 civil war.

Their official role has been to maintain internal security, but last month Syrian units clashed for the first time with Israeli-backed forces in the South Lebanon. The Syrian and Israeli air forces have also fought several times over southern Lebanon.

Kasbi was quoted as saying "if Lebanon's legitimate authorities ask us to withdraw, then we would withdraw, but not to place our head under the Israeli knife." "Therefore, we shall remain in Lebanon if our withdrawal would lead to Israeli expansion."

Maj.-Gen. Mustafa Tlass, the Syrian defense minister, indicated a change in the role of the deterrent force last month when he said in a speech that Syria's policy of confronting Israel in Lebanon was "established and firm." Kasbi's remarks coincided with a Lebanese government request for a six-month extension of the ADF mandate, which expires on Jan. 27.

The Qatar News Agency reported Tuesday that the Arab League will consider the request at a meeting in Tunis next Tuesday. Lebanese Prime Minister Shafiq Wazzan said Tuesday his government still considered the deterrent force to be part of the legitimate security authorities in Lebanon.

Haig airs M.E. policy Tells Congress U.S. interests need priority

By Bob Lebling and Fawzi Asmar Washington Bureau

WASHINGTON, Jan. 14 — Secretary of State-designate Alexander Haig, in his testimony this week before the Senate, has indicated he will pursue a Middle East policy supportive of American and Western interests and at the same time sensitive to the realities of the region.

The former NATO commander has told senators at his confirmation hearings that the U.S. must be prepared to act — alone if necessary — to protect the West's access to Arabian Gulf oil. Haig said NATO itself could not be counted on to expand its defense commitments to include this strategically key region.

Haig's perspectives on the Middle East have been heavily influenced by his concern for the security of America's allies in western Europe, analysts noted.

This concern has resulted in a pragmatic desire to bolster U.S. ties with friendly Arab states in the area and to seek a comprehensive solution to the Arab-Israeli dispute, these analysts said.

Haig told the Senate Foreign Relations Committee that if he had been secretary of state when Saudi Arabia requested its original purchase of advanced F-15 aircraft, he would have supported the sale.

The secretary-designate believes that if America asks something of its friends and allies, it should be prepared to give something in return, analysts noted. Under the new administration, this could mean a greater U.S. responsiveness to the needs and requests of America's friends in the Arab world.

Haig — 36, the administration generally — have not yet formulated a definite strategy for dealing with Middle East issues, informed sources said. They are still studying the issues and gathering input from various quarters, according to the sources.

Reagan plans to send vice-President George Bush on a Middle East tour within the next few months, and Bush will be carrying invitations for leaders in the region to visit Washington and meet with the president.

These meetings with Arab leaders should prove decisive in shaping the new administration's Middle East policies, analysts noted.

Meanwhile, Israel's leading Hebrew newspaper, *Ha'aretz*, has reported that when Haig was nominated secretary of state, he immediately cut off his contacts with the Israelis, some of whom were his personal friends.

Sources here said Haig took this action to avoid being unduly influenced by Israel as he took up his new government post.

Two U.S. planes crash; four killed

RAMSTEIN, West Germany, Jan. 14 (AFP) — At least four persons died Wednesday in two separate incidents involving U.S. military aircraft when a C-130 Hercules transport jet crashed on take-off here and a Phantom fighter crashed in Spain.

The Hercules, with a crew of nine, ploughed into an ammunition dump in Weilerbach, near the U.S. air base here, the Ramstein spokesman said.

The spokesman did not appear to have full details of the crash but said that "at least two" had died. He said the depot was not seriously damaged. In the second incident, a Phantom fighter from the U.S. base at Torrejon crashed some 150 kilometers outside Madrid, killing both pilots. The bodies were taken to the U.S. base at Saragossa.

Kidnappers free Durso

ROME, Jan. 14 (AFP) — Kidnapper Italian judge Giovanni Durso is freed and admitted to hospital in Rome, it was announced here Wednesday.

(See story on Page 10)

Haig is apparently trying to develop a balanced view of the Middle East, these sources said.

Referring to South Korea, Haig told the committee he will make an unscheduled stop in Jordan during his Middle East tour. He presumably will ask King Hussein's help in ending the Iraqi-Iranian war.

Zia told a news conference he would visit Jordan for a few hours Thursday and that he would pay his respects to the king. He would not say what the two leaders would discuss. He was concluding a two-day visit to Ankara, the first by any head of state since the Sept. 12 coup. During the visit he and Gen. Kenan Evren discussed their "unanimous views on all bilateral and almost all international topics," the Pakistani leader said.

Zia said Turkey and Pakistan would take a "unity of views" and an "identity of values" to the Islamic summit which opens Jan. 25 in Mecca.

Speaking on Pakistan, the president ruled out an early return to civilian government or a renewal of party political activity.

He said the armed forces had taken control in Pakistan "to end disorder and put a continually worsening economy back on its feet."

"We are not thinking of reintroducing a civilian cabinet and everyone agrees with us," he said.

Neither was taking sides in the Gulf war, but they were working together to try to ensure both Iran and Iraq attended the Islamic conference.

Pakistan and Turkey would also try to act as intermediaries in the differences between Arab countries, Zia said. Both supported the creation of a separate Palestinian state as the best hope of peace, and were opposed to Israeli occupation of Arab lands.

He denied that the proposals for talks involving Pakistan, Iran and Afghanistan under the aegis of the United Nations, indicated a departure from the Pakistani policy. He said: "This does not amount to a new initiative. We are not compromising on our previous principles."

Peking asks U.S. to stop sale of arms to Taipei

PEKING, Jan. 14 (AFP) — Less than a week before the inauguration of U.S. President-elect Ronald Reagan, China has issued a double warning to Washington over its arms sales to Nationalist China. In its latest edition, *The Peking Review* said the continuation of U.S. arms sales to the nationalist government "will only make the Taiwan authorities more arrogant to obstruct the peaceful reunification of Taiwan with the motherland."

The *Peking Review*, a weekly catering to foreign readership, claimed the question of Taiwan, seat of the nationalist government since the Communist takeover in Peking in 1949, was a purely domestic Chinese affair.

"It is our hope that Taiwan returns the embrace of the Motherland peacefully," it added. "But if we are driven by the Taiwan authorities' adamant refusal to resort to non-peaceful means to solve the issue, that is entirely China's internal affair which the United States has no right to meddle in," the weekly asserted.

The issue of the warning through *The Peking Review* coincided with a mounting controversy between Peking and the Hague over the proposed sale of two Dutch submarines to Nationalist China. In a stern ultimatum, China early this month urged the Hague to take "immediate" measures to

which in strategic terms has looked on South Korea as a dagger pointed at the heart of Tokyo.

"In unfriendly hands or even in disputed hands it would be very unsettling to Tokyo," he said. "It would have a comparable impact throughout the (Asian allied) area."

"And perhaps most important of all, I think it would convey to China a message that would be very self-defeating at this time," he said.

He did not elaborate, but his comments suggested removal of the U.S. forces would suggest to Peking that the United States is no longer committed to South Korea's survival.

Zia in Jordan today

ANKARA, Turkey, Jan. 14 (AP) — Pakistani President Zia Ul-Haq confirmed Wednesday he will make an unscheduled stop in Jordan during his Middle East tour. He presumably will ask King Hussein's help in ending the Iraqi-Iranian war.

Zia told a news conference he would visit Jordan for a few hours Thursday and that he would pay his respects to the king. He would not say what the two leaders would discuss. He was concluding a two-day visit to Ankara, the first by any head of state since the Sept. 12 coup. During the visit he and Gen. Kenan Evren discussed their "unanimous views on all bilateral and almost all international topics," the Pakistani leader said.

Zia said Turkey and Pakistan would take a "unity of views" and an "identity of values" to the Islamic summit which opens Jan. 25 in Mecca.

Speaking on Pakistan, the president ruled out an early return to civilian government or a renewal of party political activity.

He said the armed forces had taken control in Pakistan "to end disorder and put a continually worsening economy back on its feet."

"We are not thinking of reintroducing a civilian cabinet and everyone agrees with us," he said.

that the time has not come for organizing elections." Since the Soviet intervention in Afghanistan, Pakistan now had a superpower as a neighbor and considered itself a "front-line state," the President said. Pakistan deplored the Soviet move but still hoped for good relations with Moscow, he added.

Zia said he understood the position of Turkey, the sole Islamic member of the North Atlantic Treaty Organization (NATO) as it was in a strategic zone and anxious to preserve its interest.

Neither was taking sides in the Gulf war, but they were working together to try to ensure both Iran and Iraq attended the Islamic conference.

Pakistan and Turkey would also try to act as intermediaries in the differences between Arab countries, Zia said. Both supported the creation of a separate Palestinian state as the best hope of peace, and were opposed to Israeli occupation of Arab lands.

He denied that the proposals for talks involving Pakistan, Iran and Afghanistan under the aegis of the United Nations, indicated a departure from the Pakistani policy. He said: "This does not amount to a new initiative. We are not compromising on our previous principles."

scrap the dropped sale. But observers said this warning was also directed against the United States.

Dutch diplomatic sources said the Chinese government told Dutch Ambassador to China Jan Kneppelhout that in Peking's view, selling arms to Nationalist China amounts to recognition of the "two-China" policy. China said should the Hague fail to act to scrap the sale worth some \$500 million, it would recall its ambassador in The Hague Mrs. Ding Xuesing. Reagan was precisely accused by Chinese leaders of advocating this "two-China" principle during the U.S. election campaign when he called for the restoration of government relations between Washington and Taipei.

Since Reagan's victory, China has made repeated gestures of appeasement stressing its will to keep developing relations with the United States "on the basis of the joint communique on the establishment of diplomatic relations between the two countries.

Through statements to journalists, Chinese leaders have even made it known that they would be prepared to receive Reagan in Peking straight after his inauguration.

The *People's Daily* has described the president-elect as both moderate and pragmatic.

AL HAJRY INSULATION INDUSTRIES POLYSTYRENE

NOW AVAILABLE POLYSTYRENE INSULATION BOARDS AND RIBS BLOCKS IN MANY THICKNESS AND SIZES.

FOR DETAILS PLEASE CONTACT **ALHAJRY COMPANY**

P.O. BOX 500, DAMMAM
PHONES: 8325073/8321796
TELEX: 601024 HAJRY SJ

WHEREVER YOU ARE BAKHEET WILL SERVE YOU

KOBELO EXCAVATORS

BAKHEET CO.

Kilo 6, Medina Road
P.O. Box 6101, Jeddah, Saudi Arabia
Tel: 6652138/6600494
Telex: 401807 BAKHET SJ

Riyadh: 478-1821, Damman: 832-2327
D.R.: Mecca: 452-0571, Medina: 822-4965

14% p.a.

For 2 and 3 year Fixed Time Deposits

Interest paid annually

Other rates for 1-5 years are available.

All interest paid without deduction of tax at source.

Save with Lombard

JAMJOOM HOTEL JEDDAH

Our New Telephone Nos. are 653-3578 & 653-3587

You simply dial we will pick you up from Jeddah Airport Tauba St. Near Jeddah Towers Building — Sharafia, Jeddah

Post this coupon to the Deposit Accounts Manager for a copy of our Booklet and current rates of interest.

To: **Lombard North Central Ltd.**
DEPT. 800,
17 BRITON STREET,
LONDON W1A 3DH.
TEL: 409 3434

Lombard North Central Deposit Accounts

Name _____

Address _____

The rate quoted is correct at time of being sent to press.

A member of the National Westminster Bank Group, whose capital and reserves exceed £1,500,000,000.

Nazer stresses 3rd plan

Calls Kingdom unique

Houston Bureau

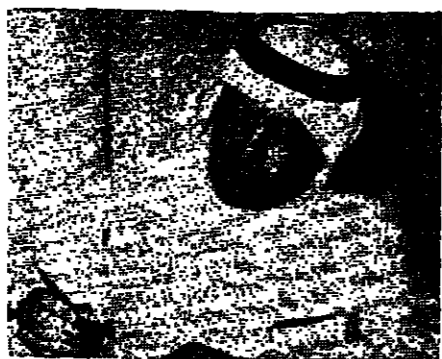

Sheikh Hisham Nazer

HOUSTON, Jan. 14 — Saudi Arabia's unique position economically is part of a developing world order that will require sacrifices among industrialized nations of certain industrial activities, including hydrocarbon-based industrialization, according to Saudi Planning Minister Sheikh Hisham Nazer.

Speaking in Houston Tuesday, Sheikh Nazer said the Kingdom's unprecedented growth under the first and second five-year development plans brought about many misconceptions that the growth has been haphazard. He emphasized that such misconceptions are generated by foreigners who try to generalize Saudi Arabia's development in comparison to other nations that try to combine public and private sector development.

But Sheikh Nazer cited the example of how the Kingdom's inflation rate has dropped from 30 per cent to 10 per cent as proof of the government's ability to improve — not obstruct — economic development. He noted, however, that this success was due to the Kingdom's unique situation as a highly integrated society with 85 per cent of its revenues coming from petroleum.

"We have been careful not to fall prey to following economic theories or positions apart from the particular application to our unique situation. For example, we see no real conflict between professing confidence in the free enterprise system and simultaneously providing direct financial assistance to the private sector," Sheikh Nazer said.

He said the coming years will see a shift in the hiring trends within the Kingdom from manual-labor workers to the hiring of skilled, highly educated workers. This trend will develop as the infrastructure development, characterized by the first two five-year plans, changes to a more capital-intensive and research-intensive development in the third five-year plan.

He indicated that this trend could mean less foreign labor will be needed to carry out the development plans, since the major emphasis will be production of marketable goods using Saudi manpower and Saudi brain-power.

Sheik Nazer noted at the outset of his speech that a major aspect of Saudi Arabia's economic uniqueness involves the integration of development plans with — not apart from — the Islamic faith.

"The Islamic traditions guiding our country are not really separate from the economic decisions we make," he said. "Each and every gesture derives from and is within the larger context of our full commitment to our Islamic traditions and beliefs."

UAE donates mosque funds

MECCA, Jan. 14 (SPA) — Muslim World League Secretary General Sheikh Muhammad Ali Al-Haraki received \$167,205 donation from Sheikh Zayed ibn Sultan Al-Nahyan, president of the United Arab Emirates, Wednesday.

The donation came in response to an appeal by the Higher World Council of Mosques for assistance in building a mosque in Jammu, Kashmir, and appointing Muslim advocates in Paris to promote the spreading of Islam through the MWL's bureau there.

ABT
BULK & BAGGED CEMENT
Arabian Bulk Trade Ltd.
Al-Khobar: Tel. 8644848 - 8645351, P.O. Box: 2194, Tlx: 670354 SABUT SJ.
Riyadh: Tel: 4789323, Telex: 201175 XENEL SJ.

Islamic university holds pre-summit ceremony

Under Prince Salman

RIYADH, Jan. 14 (SPA) — Imam Muhammad ibn Saud Islamic University held a ceremony Tuesday night for Islamic Solidarity on the occasion of the upcoming Islamic Summit conference to open in Mecca Jan. 25.

The ceremony was held under the auspices of Riyadh Governor Prince Salman. It was attended by Dr. Abdullah Al-Turki, rector of IMISU; Muslim ulema, scholars, university personnel and students.

Prince Salman addressed the audience on the occasion and said that the ceremony was

a good start for the Islamic summit conference. He expressed his pleasure for the festival and said the Kingdom had the great honor of hosting the conference to be attended by all Muslim leaders. Saudi Arabia, shouldering its great responsibility, saves no effort in working for Islamic solidarity and unity, he said.

Referring to the first Islamic summit conference held in Mecca in 1924, Prince Salman said that it was called for by the late King Abdul Aziz. Then the call for an Islamic summit was suspended until the late King Faisal revived

the call in the early 1960's. The Rabat and Lahore Islamic summits were attacked by Communists and others and were described as a call for an Islamic past, the prince said.

He expressed hope that the Mecca summit would succeed in serving Islam and Muslims by uniting them and fighting their enemies. Muslims would not be successful unless they fully adhere to the principles and teachings of the Islamic religion, Prince Salman said.

Dr. Abdullah Al-Turki also reiterated the importance of the Mecca summit. He thanked Prince Salman for attending the ceremony and said his action proves the government's attention to any meetings serving Islam and Muslims.

The rector said Muslims adhere to principles and teachings that had not been created by temporary experiences or incidents. The Islamic history is not linked to any pacts or blocs, Dr. Turki added.

Dr. Omar Jah, speaking on behalf of IMISU's staff, hailed the Kingdom's finan-

cial and moral support to knowledge seekers in all Islamic countries. Ghulam Farouq, who delivered the students' statement, said that university was honored to organize the ceremony that stated IMISU's solidarity with the coming Islamic summit.

Several poems were read, and an expressive play under the title of *Jerusalem, What is the Solution?* was performed by university students.

Girls' school pact let

AL-KHOBAR, Jan. 14 (SPA) — The Directorate General for Girls' Education in Al-Khobar awarded a contract for building an intermediate and secondary schools in the southern part of the city. The SR14 million contract was won by a Saudi Arabian company. The contract calls for building two schools of 23 classrooms each in addition to a meeting hall, a laboratory, a domestic science room, technical education room, a mosque and gardens within 14 months. Air conditioning the buildings is also included in the contract.

Saudia board meeting held

To discuss services

RIYADH, Jan. 14 (SPA) — The board of directors for Saudia airlines met here under Defense and Aviation Minister Prince Sultan, the chairman, Tuesday. The meeting discussed improving Saudia's services.

The board reviewed technical and development issues regarding Saudia's services in various fields. The meeting, lasting two days, discussed the airline's budget which was to be further studied. Discussions of present and future development and expansion

plans were to be completed during Wednesday's meeting.

The meeting was attended by Finance and National Economy Minister Sheikh Muhammad Aba Al-Khail, Communications Minister Sheikh Hussain Mansouri, State Minister and Cabinet member Dr. Muhammad Al-Lahm, Assistant Defense Minister for Civil Aviation Sheikh Kamel Sindi, Saudia Director General Sheikh Ahmad Matar and other members of the board of directors.

BRIEFS

Emirs cable thanks
RIMAH, Jan. 14 (SPA) — Residents of Rimah and Ruhaima and their emirs cabled King Khaled and Crown Prince Fahd their thanks for linking their village to Riyadh with an asphalted road as the rest of the region's villages. The road linking two villages to the capital was opened last week.

PLO ceremony planned
HASA, Jan. 14 (SPA) — Hasa Governor Prince Muhammad ibn Fahd Al-Jilwi will attend a ceremony Saturday on the occasion of the 16th anniversary of the Palestine Revolution. The ceremony will be held at the PLO's office in Hasa and will be attended by Rafiq Shaker Al-Natsha, the organization's representative in the Kingdom.

Al-Anqari returns
RIYADH, Jan. 14 (SPA) — Labor and Social Affairs Minister Sheikh Ibrahim Al-Anqari returned here Wednesday from Abu Dhabi after attending the third session meetings of the Council of Labor and Social Affairs Ministers of Gulf states concluded Tuesday. Among the decisions of the conference was a call to unify regulations of social welfare organizations in the Gulf.

Koran translated
MECCA, Jan. 14 (SPA) — The General Secretariat of the Muslim World League is

working on translating the holy Koran to the Bangali language. The League's Islamabad bureau will be in charge of the operation. The MWL had recently completed translating the holy book to the Japanese, Hausa and other African languages.

Cultural show held
DAMMAM, Jan. 14 (SPA) — The Saudi Arabian Cultural and Arts Society held its third ceremony here Wednesday. The ceremony was organized by the society's branch at the Industrial Institute of Dammam. A variety of recreational, cultural, folk-dances, songs and poems were performed during the evening with the aim of preserving the local traditions.

Table tennis scheduled
DAMMAM, Jan. 14 (SPA) — The table-tennis championship for intermediate colleges and science and mathematics centers will begin March 4, it was reported. The championship will be held at the Intermediate College and Science and Mathematics Center of Dammam. Seven colleges and three centers will take part in the two-day championship.

IDB pact signed
JEDDAH, Jan. 14 (SPA) — The Islamic Development Bank has loaned the Comoro Islands \$2.5 million to help it buy refined oil from Kuwait last week.

VACANCY: BRITISH AIRWAYS NEED A
MALE SECRETARY
SHORTHAND ESSENTIAL

APPLICANTS WITH TRAVEL BUSINESS EXPERIENCE AND ARABIC SKILLS WILL BE GIVEN PREFERENCE

- MINIMUM 5 YEARS EXPERIENCE ESSENTIAL
- MINIMUM SHORTHAND SPEED: 50 WPM
- MINIMUM TYPING SPEED: 70 WPM

SALARY ACCORDING TO EXPERIENCE / SKILLS

APPLY IN WRITING **British Airways** JEDDAH SHOPPING CENTRE
OR IN PERSON TO P.O. BOX: 439 JEDDAH
BEFORE 24 JANUARY

NOW... NCC
That we have got the great Concrete pumps, We can solve the problems of tomorrow today

National Concrete Co.
Behind the airport P.O. Box: 6548
Tel: 6650491, Jeddah

Visit the Middle East's most prestigious International Building and Construction Exhibition.

Middle East Construction Exhibition

Jeddah Expo Center Kingdom of Saudi Arabia 15/21 January 1981

Take this opportunity to see the very latest in building materials, construction equipment, trucks, prefabricated and system buildings, scaffolding, formwork, furnishings and services.

A large contingent of Saudi exhibitors will be joined by companies from Australia, Austria, Belgium, Canada, Finland, France, Holland, India, Italy, Korea, Pakistan, Portugal, Spain, Sweden, Switzerland, Taiwan, UAE, UK, USA and West Germany.

The Expo Center is only 15 minutes drive from Jeddah Airport and most Jeddah hotels. The Exhibition opens 15 January 17.00-22.00 hours and daily from 16 January to 21 January 10.00-15.00 hours and 17.00-22.00 hours.

Admission is free to all involved in government, building, construction and all related industries. Attendance is expected to exceed last year's when over 15,000 people, representing every sector of the industry from Saudi Arabia and other Middle East countries, visited the show. Don't miss it!

For further information contact: Al Harithy (Exhibition and Services Division), P.O. Box 6249, Jeddah, Kingdom of Saudi Arabia. Telephone: 6674788. Telex: 401428 REEM SJ. Or: Fairs and Exhibitions Limited, 21 Park Square East, London NW1 4LH, England. Telephone: 01-935 8200. Telex: 299708 EFAEE G.

Organized by Fairs and Exhibitions Limited in association with Al Harithy Company of Jeddah (Exhibition and Services Division). Promotion by Middle East Construction Magazine. Official carriers Saudi Arabian Airlines.

Five...Four...Three...Two...One... ...Lift off!

MIDDLE EAST CONSTRUCTION EXHIBITION JEDDAH JAN 15-21

DAF Trucks

Saudi Arabian Truck Agencies
P.O. Box 8022
Jeddah
Saudi Arabia
Tel: 675717 Telex: 402710

The Sturdy Ones

Riyadh Philanthropic Society

Charity complex discussed

RIYADH, Jan. 14 (SPA) — The Board of the Riyadh Philanthropic Society met here Tuesday night under Riyadh Governor Prince Sultan, the chairman of the committee. The meeting was attended by Deputy Riyadh

Governor Prince Sattam and members of the board and the society.

Sheikh Abdul Aziz Al-Misnid, secretary general of the society, said the board discussed a charitable complex project the society intends to build in Darayya. The project was studied and its cost was estimated at SR50 million by an engineering firm. The complex will have a Koran memorization school, a mosque, a library and other necessary facilities.

The board agreed to let a tender for the project and immediately start construction work, Misnid said. The board also considered another project for constructing buildings on two land plots owned by the society. Three members of the board were appointed to study the project and submit a report.

The board reviewed aid provided to subscribers, the society's income and expenditure last year. The society's income amounted to SR19 million including the late King Faisal's grants. Assistance was distributed to beneficiaries in Riyadh through the society's offices and across the Kingdom through other welfare societies, Misnid said.

He added that the board has drawn an accurate method to find subscribers and ways of paying them. The society adopted a system to pay beneficiaries through schools in cooperation with the Ministry of Education, he said.

The board decided to hold regular meetings at the beginning of every month. Sheikh Misnid thanked Prince Salman, prince Sattam and all members of the board for their moral and financial support to improve the society's function.



Prince Salman

Prayer Times

Thursday	Mecca	Medina	Nejd
Fajr	3.36	5.43	5.14
Ashraq	7.01	7.08	6.39
Dhuhr	12.30	12.31	12.02
Asr	3.38	3.34	3.05
Maghreb	6.00	5.56	4.27
Isha	7.30	7.26	6.57



TRUCKS: Volvo's No. 10, considered an all-round truck for tipper, tractor unit or special applications.

Zahid Tractor takes on Volvo

By a Staff Writer

JEDDAH, Jan. 14 — Volvo trucks in Saudi Arabia now are represented by Zahid Tractor and Heavy Machinery Co. Ltd. a press statement reported Wednesday. Zahid Tractor has seven branches throughout the Kingdom and will open another two in 1981, the report added.

Volvo Truck Corporation is one of the leading manufacturers of heavy trucks in the world, the statement said. A total of 28,000 Volvo trucks were produced during 1979

which was an increase of more than 10 per cent compared with the previous year. Close to 90 per cent was exported to about 65 foreign countries, the company said. Volvo is the largest exporter of heavy trucks to Europe, the report added.

According to a Zahid Tractor announcement, Zahid workshops are equipped with original Volvo parts and special tools to make workshop operations faster and safer. The workshop staff have been specially trained to do the job of meeting Volvo's rigorous standards, the statement added.

Medina phone payment due

RIYADH, Jan. 14 — Saudi Telephone said that Medina subscribers have until January 20, 1981 (Rabi' Awal 14, 1401) as the last date for payment of telephone bills. January 20 is the "maturity date" for Medina subscribers. Subscribers who have not paid by

January 20 will have their telephones disconnected and the telephone number re-assigned to another customer. Late subscribers will therefore have to re-apply for telephone service, the company said.

Ahmad calls summit well-timed

RIYADH, Jan. 14 (SPA) — Deputy Interior Minister Prince Ahmad said the Mecca Islamic summit conference is well timed regarding the Muslim world's need for a collective action at the level of heads of state and governments.

Prince Ahmad said Tuesday night the summit would discuss every issue that concerns Islam and Muslims, and get all Islamic states together to confront the dangers they are facing from the struggle of superpowers over influence.

The meeting of Muslim leaders and their deliberations on the concerns of the Muslim

world will certainly have results eagerly awaited by Muslims everywhere, he said. The Kingdom, led by King Khaled and Crown Prince Fahd, has mobilized every potential to make the summit conference a success, especially that it is to be held in Mecca, Prince Ahmad said.

The gathering of a large number of kings, rulers, heads of state and governments representing all Islamic countries in the sacred place revives the hopes of Muslims for security, prosperity and progress towards their cherished aspirations with greater adherence to the holy Koran and the Prophet's Sunna in all their worldly affairs, the prince concluded.

COMMENT

By Muhammad Omar Al-Amoadi
Al Medina

The foreign capital investment system had not been introduced just to encourage foreign capital to function in the country, but the basic purpose behind it was to bring technical know-how into the country to enable the native worker to handle equipment and manage projects all by himself. This aim cannot be achieved unless he is given opportunity to learn and gain experience in work.

The native worker still occupies the marginal position in industry, while it also suffices him to hold the position of public relations or just to process cases at the immigration office or police station.

Who is to be held responsible for this state of affairs? Shall we say it is the foreign expertise that keeps the native isolated, or is it due to the shortage of native manpower? Some may also think there is some shortcoming in the regulations, especially investment regulations, which have ignored an explanation on this aspect.

A few examples may be enough to

explain our purpose. A Saudi Arabian financier desiring to set up a perfumery, enters into an agreement with a French expert. The agreement provides that the French expert would look after technical supervision while the Saudi partner will only have to go through the budget at the close of the year and receive his share of the annual profit. He is designated as chairman of the board of directors, which is no more than an honorary doctorate conferred on people who believe they are real doctors!

In another example, a native financier sets up an industrial project with his own funds and immediately brings in a company specialized in administration. This practice has begun to creep into many projects. It is, indeed, hard to understand that an individual or the state should import a management staff for running a multi-million hospital. The most prudent thing, in our view, would be to combine the foreign expertise with native elements in such a way that the latter benefits from the former. This, I think, is a matter that should not be left to the will of individuals but ought to be imposed by law. If not, we shall remain where we are.

binzagr barber
binzagr saudi shipping co. ltd.,

WE ARE PLEASED TO ANNOUNCE
RELOCATION OF RIYADH OFFICE
AT ALHASA STREET
SHOBOKSHI BLDG. 2 ND FLR.
OPPOSITE ALHAMRANI ENT. (DATSUN)
TLX: 200696 BINBAR SJ
TEL: 477 0663 EXT. 227
WORKING HOURS 0800 - 1200 HRS
1230 - 1630 HRS.

RIYADH SHINES IN THE WORLD
and so does the Book

RIYADH CITIGUIDE

SPECIAL 1981 OFFER!
25 SR.

The best thoughts start with... **SHEAFFER**

SHEAFFER FAVORITE TITANIUM

Linowitz sees talks 'easier' with Peres

DETROIT, Jan. 14 (AP) — Elections in Israel could make peace talks with Egypt much easier, in the view of Linowitz, U.S. President Jimmy Carter's envoy in the negotiations. "In some ways, a Labor Party would be more forthcoming than the Begin government has been, but that, of course, would only be after the election," Linowitz said Tuesday at a news conference in Detroit.

Israeli polls show that Shimon Peres and the Labor Party would easily defeat Begin if an election were held today said Linowitz, in an address to the Economic Club of Detroit. "Notwithstanding the elections, the opportunities for progress remain considerable," Linowitz said. "My hunch is that Prime Minister Begin will want to appear as a peacemaker...and therefore he will push for

an agreement."

Begin said Monday in Jerusalem that he favors early elections, which are being precipitated by the resignation Sunday of Finance Minister Yigael Hurwitz.

Linowitz, who has represented Carter at the talks for 15 months, said President-elect Ronald Reagan should replace him with someone Reagan trusts.

Though Henry Kissinger is "eminently qualified" to take his place, Linowitz said, Kissinger might not be close enough to Reagan to be an effective negotiator. All but five "basic issues" dealing with Palestinian autonomy have been settled in the talks, Linowitz said. "There are no insoluble problems we are dealing with."



Sol Linowitz

Egypt, Israel resume autonomy talks

TEL AVIV, Jan. 14 (R) — Israel and Egypt resumed autonomy talks here Wednesday to sum up 18 months of deliberation by both sides on granting limited self-rule to residents of Israeli-occupied territory. The Egyptian delegation was headed by Ambassador Ahmad Ezzat el-Latif and the Israeli side by the director-general of the interior ministry, Haim Kubersky.

Israeli officials said the object of the talks was to present an up-to-date report to the new American administration when President-elect Ronald Reagan assumes office later this month. The American delegation to the talks arrived here Tuesday and held a preliminary meeting with Kubersky and other members of the Israeli team, according to an official announcement.

El Al technicians go on strike

TEL AVIV, Jan. 14 (R) — Maintenance technicians of the Israeli airline El Al went on strike Tuesday and said they would refuse to service outgoing aircraft.

The company was trying Tuesday night to transfer passengers to other airlines and its directors said they were asking a court to issue an injunction ordering the technicians back to work.

The maintenance workers said a management proposal to implement a stringent economy program to help the airline out of its financial difficulties was a violation of work contracts.

Government aid to El Al has been held up until the company implements the economy measures, including a large number of dismissals, the abolition of unprofitable routes and closure of many of its overseas offices.

Syrian official holds Moscow talks

MOSCOW, Jan. 14 (R) — Soviet Defense Minister Dmitry Ustinov had talks in Moscow with the Chief of Syria's General Staff Gen. Hikmat al-Shahabi, Tass reported Tuesday. Tass said the general, whose presence had not earlier been reported in the Soviet media, was in Moscow on a business visit. He discussed

questions of mutual interest with Ustinov, Tass said.

Although the agency gave no other details, it seemed likely that the two had discussed Soviet arms supplies to Syria, which last year signed a friendship treaty with the Soviet Union.

Egypt expels two Soviet diplomats

CAIRO, Jan. 14 (R) — Egypt has ordered the expulsion of two Soviet diplomats, arrested another Soviet embassy official and given political asylum to a Soviet book sales representative, Egyptian officials said Tuesday. The officials said Yuri Marchetko, who works in the Soviet embassy's economic assistance bureau, was under detention charged with trying to obtain classified information

from public employees.

They said Egypt had given political asylum to Vladislav Kharlov, the representative of a Soviet book trading firm who Monday walked into the offices of the semi-official newspaper *Al-Ahram* and asked for protection. *Al-Ahram* said Kharlov, 59, had complained of harassment from embassy staff following a drop in his firm's sales.

Turkish chief editor released

ISTANBUL, Jan. 14 (AP) — Martial law authorities released the chief editor of Turkey's largest-circulation newspaper Tuesday night, but its managing editor remained in jail newspaper spokesmen said Wednesday. Erol Turegun, managing editor of *Hurriyet*, was still being held at the Turkey martial law command as military prosecutors investigated the paper's alleged refusal to publish the government's comments on prices of state-produced goods such as cigarettes and liquor.

Plainclothes policemen had detained chief editor Salim Bayar, 57, Sunday. The controversy involved an order by Premier Bulent Ulusu to roll back planned price hikes in basic utility services and state-manufactured goods.

Hurriyet spokesmen said the paper's three correspondents who worked on the story in the capital of Ankara were also summoned to testify in connection with the investigation carried out by the Istanbul martial law command.

In another development Turkish narcotics police seized about 100 kilograms of hashish worth \$500,000 in raids in Istanbul and Adana, police announced Tuesday. A narcotics team found 66 kilograms of hashish placed in the seat cushions of a car owned by a peddler in Istanbul.

Police said Metin Ardic who had a police record of past cigarette smuggling apparently intended to take the car out of country. They said three other drug smugglers believed to be members of a ring were also arrested: In Adana, southern Turkey, police found sacks of hashish scattered about a beach along the Mediterranean coast, police reported.

Bourguiba to pardon five union leaders

TUNIS, Jan. 14 (AFP) — Tunisian President Habib Bourguiba has decided to restore the civil rights of five union leaders freed earlier after serving jail terms as a result of the January 1978 unrest and general strike, Premier Muhammad Mzali announced here Tuesday. He said the 77-year-old head of state had made the move to mark the 35th anniversary next week of the founding of the General Union of Tunisian Workers (UGTT), which was at the center of the unrest. Thirty of its leaders were tried and convicted in September 1978 of subversion

and other charges.

All but three of the union's executive have now had their rights restored — the union's former secretary-general, Habib Achor, his private secretary, and the regional leader of the UGTT, Abdenazak Ghorbal. The five to be pardoned are Muhammad Dami, Muhammad Ezzedin, Hassen Hamuda, Ismail Sahbani and Muhammad Shakrun. Mzali also announced the appointments of new people to head the ruling party's newspapers and magazines.



President Habib Bourguiba

البنك السعودي الأمريكي Saudi American Bank



wishes to inform its customers that the Khashoggi Branch on Airport Road

will be closed for business during the evening banking hours (5 p. m. - 7 p. m.)

on

Sunday, January 18

due to

the Bank's Official Inauguration

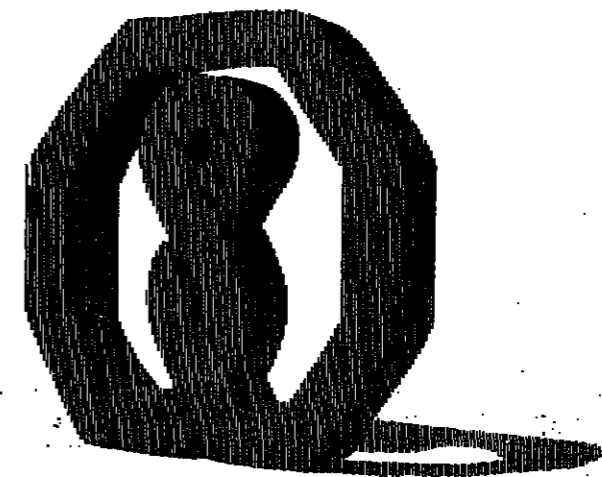

It's a German Foodweek in Riyadh.

A delicious variety of German Food and German beverages will be offered in Riyadh on Jan. 15-22 in the following Supermarkets:

- City Supermarket - Al Ullaiya
- Greenhouse - Airport Road
- Johar Shopping Center - Al Ullaiya
- Johar Shopping Center - Jareer Street
- Johar Shopping Center - Nassarieh Street
- Riyadh Supermarket - Airport Road
- Najd Center - Jareer Street
- Al Jawaie Al Jamaah Supermarket
- Hussam Store - Damman Road

Sampling times daily from 4 p. m. to 9,30 p. m. We cordially invite you to taste the delicious variety of German foodstuffs and German beverages.

MOTHERS VISIT
CHILDLAND
WE HAVE EVERYTHING FOR YOUNG CHILDREN AND TEENAGERS.
AT SITTEEN STREET, JEDDAH NEAR AMERICAN FURNITURE TEL: 655330

Escape.

Renault. Uncommon cars for uncommon roads.

Just imagine the fun of your dreams, and discover the Renault 18 reality. Taste the front wheel drive pleasure, feel the power, enjoy the equipment and live the comfort. It's all so different if you wish and automatically it goes so better. Escape in a Renault 18.

Renault 18

Agents in Saudi Arabia UNITED BROTHERS COMPANY
Riyadh: Show room, Prince Abdullah Bin Abdul Aziz street near Al Drias station. Tel.: 4775938
Jeddah: Show room, Beginning of Al Medina road, El Khareij roundabout. P.O. Box: 6093 Tel.: 6533287 - 6533291
Telex: 401177 UBC SJ

Islamic Chamber -- objectives, performance and prospects

By Agha Muhammad Ghose

JEDDAH — The advent of the 15th century Hijra has witnessed, by the Grace of Allah, a determined consolidation of the institutional structure needed for economic collaboration among the Islamic countries. This has followed the political independence gained by the Islamic world during the 14th century Hijra. Indeed, the charter of the Organization of the Islamic Conference (OIC) adopted in March, 1972, at Jeddah has not only been a source of inspiration to the Islamic Ummah but has paved the way for setting up specialized institutions to ensure economic cooperation among the member countries.

The Islamic Chamber of Commerce, Industry and Commodity Exchange is one such specialized agency. The role of the chamber should, therefore, be understood as a link in the service of Islamic Ummah along with other institutions like the Islamic Development Bank at Jeddah, the Statistical and Economic Research Center at Ankara, the Training Center at Dacca and the newly formed Trade Center at Tangiers.

The Islamic Chamber has completed two years of its existence. Its constitution was unanimously adopted at the second conference of the National Chambers of Commerce and Industry of the Islamic countries held in Karachi, Pakistan, in December, 1978, when it resolved to locate its headquarters in Karachi. It also unanimously elected Sheikh Ismail Abu Dawood as its president along with six vice presidents (representing six zones in which the 42 member countries of the OIC from Morocco to Indonesia have been grouped) and 12 other members for the executive committee.

It is noteworthy that the Islamic Chamber is meant to organize close collaboration of private enterprise in trade, industry and other economic fields through the National Chambers of Commerce and Industry. Earlier the OIC had established specialized organizations in the public sector through financial contributions from governments. The finances of the Islamic Chambers are realized through annual subscriptions from the National Chambers to the budget adopted by the general assembly. The share of individual country's subscription is worked out from the OIC formula based on per capita income and

ity to these subjects in view of its limited resources for large scale research activities.

Following the increase in OPEC oil prices, the share of Islamic countries in world exports and imports has increased. However, the inter-community OIC trade has not shown much progress as is desired by all member countries.

The share of OIC members in world exports has improved from 5.3 per cent in 1960 to 6.2 per cent in 1970 and further to 12.1 per cent in 1977. The figure for 1980, when compiled, will be again heartening. As regards OIC share in world imports, it has gone up from 5 per cent in 1960 to 8 per cent in 1977. But if we exclude the oil-exporting countries, the performance of other Islamic countries in both exports and imports is not so encouraging.

The policy options for the Islamic Ummah is quite clear. Although trade diversion from industrially advanced countries to member-OIC countries may not always be possible in the short run, there ought to be possibilities for trade among member states if a higher share of expanding imports is facilitated through deliberate policies, including tariff preferences.

It is true that tariff rates are not so high in the Middle East imports, but other member states may undertake this exercise where possibilities of financing such trade through surplus oil revenues can be worked out. Of course, the solution lies in joint ventures and sub-contracting of specific projects which can be attracted by some countries which have natural and manpower resources. Such a study is being undertaken by the Islamic Chamber and it will take some time for its fruitful completion. The need is to dovetail the present and future development targets in the industrial sector of each member country and arrive at prospective conclusions for joint ventures and sub-contracting.

At present, the share of inter-community OIC exports forms only 6 per cent of its world total exports; and for imports, it works out to only about 8 per cent. In fact, a very large number of Muslim countries have only one or two trading partners in the OIC fold. But it should also be noted that whenever the market demand was projected, especially in the Middle East, some member countries have achieved good results in this region: for example, 25 per cent of Pakistan's exports flow to the Middle East and that of Bangladesh 20 per cent.

The scope is encouraging for the future. Because 75 per cent of all imports of the Islamic countries consist of manufactured goods, the planning strategy should be the creation of exportable capacity in manufactured goods.

Although the ultimate objective is to create a Muslim common market, the goal cannot become nearer without planning for complementarity of production. The people of the Islamic world form a huge total of 900 million and the countries are endowed with diversified natural resources like minerals, agricultural commodities, technological skill and unemployed labor force. Indeed, the diversity of resources is the surest guarantee for the common market approach. Meanwhile, sub-regional collaboration among the Islamic countries in the shape of joint ventures and expanded trade in the sub-region, will also ultimately help the formation of a Muslim common market.

Besides 55 per cent of the world's oil reserves, the Islamic countries have a large share of other major commodities in international trade, such as raw jute (Bangladesh 60 per cent), rubber (52 per cent Malaysia and 22 per cent Indonesia), phosphate rock (Morocco 34 per cent, Senegal, Jordan and Tunisia notable shares), bauxite (Guinea 25 per cent) and in other items like iron ore, ground nut oil, palm oil, raw cotton and fertilizers.

In September 1980, the export group on shipping met in Karachi for the second time after its first meeting in Jeddah. It has finalized its recommendations. The forthcoming Islamic summit will have before it a number of subjects in the realm of economic collaboration including trade promotion, guarantee for investments, shipping, etc. The entire Islamic Ummah is looking forward to its conclusions, agreement and decisions on both political and economic fronts.

The time is now ripe for the Islamic countries to establish a merchant fleet. Indeed, an Islamic merchant fleet will become a catalyst for speedy economic growth of all the developing countries. At present, the developing countries are largely dependant upon shipping registered in the industrially advanced countries and in the open registry countries like Panama and Liberia for their shipping needs.

While the world shipping tonnage has increased from 217.9M (GRT) in 1970 to 407.6M (GRT) in 1979, the share of industrially advanced countries remained as high as 52 per cent in 1979, with open registry countries (in which also they have a big share) at 28 per cent and the balance of 10.2 per cent accounted for by the developing countries. The share of 10.2 per cent is an improvement for the developing countries over 6.7 of 1970. It is heartening that since 1973, the shipping fleet of the Islamic countries as a whole (and especially that of the Arab countries) has increased at a faster rate than the world trend.

It is hoped that the formation of the Islamic Shipowners Association and the Islamic Shipping Company will go a long way not only to promote and strengthen the national shipping lines but also regional collaboration in this vital trade link.

The Islamic Chamber is making efforts for pooling insurance and reinsurance business among the Islamic countries. A formal study has been entrusted to Bangladesh and a meeting of experts is scheduled to be held at Dacca in mid-1981 with the active support of the OIC. The pooling of reinsurance has great potentials for collaboration and advantages to all the member countries, in retaining foreign exchange and also lowering premia.

In all these spheres, the Islamic Chamber is making its best contribution. The second

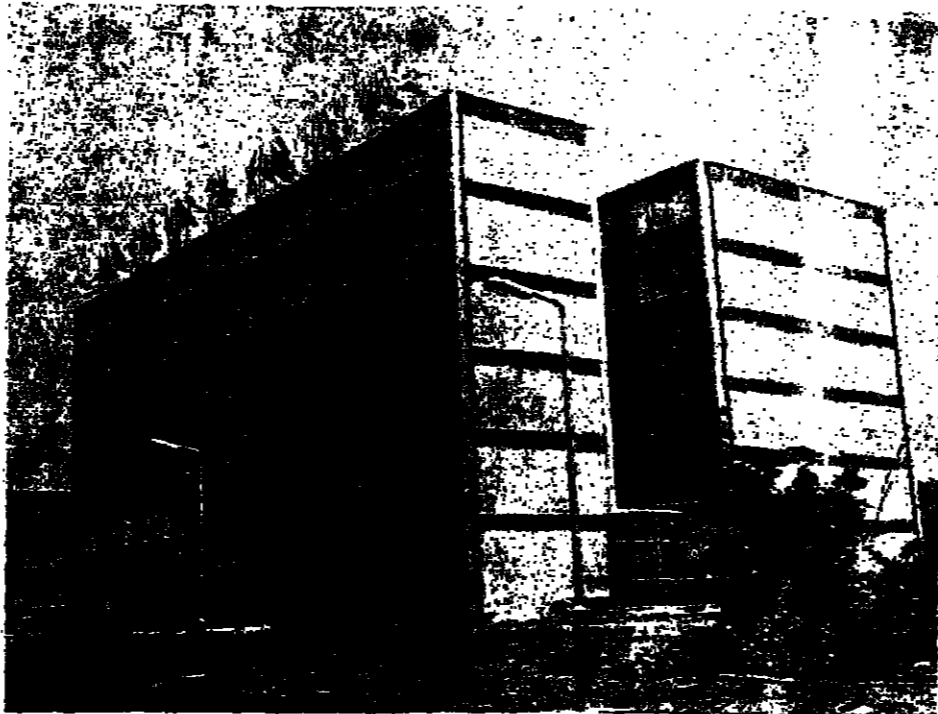

Main office of the Islamic Development Bank in Jeddah

general assembly is scheduled to meet at Kuwait in mid-February 1981. It is an occasion to review the performance and problems of the chamber and set the course for the future.

The need of the hour is dedication and patience. It is not easy to reshape the destiny

of so many Islamic countries located on a wide geographical campus. Institutionalization of the economic movement of the Islamic Ummah has started in right earnest. The Organization of the Islamic Conference is giving a clear lead to all its organs so that they can link up their activities.

'Sharia' provides good ground for banking

By Muhammad Abu Al Tahir

JEDDAH, — Some people think that Islam does not provide a good ground for banking and the ideal Islamic society is one that nips any banking activity in the bud. It is, however, an undisputable fact that the flexibility and teachings of Islam incorporate many matters of daily life with certain modifications, in order that they conform to the injunctions of the Islamic law, called the Sharia.

An article published in *Al-Tijara*, a monthly magazine of the Jeddah Chamber of Commerce and Industry, reviewed the different forms of banking activity Islam permits in the light of legal opinions formulated by Muslim jurists. The article puts them in three categories, as follows:—

Letter of Credit: In opening a Letter of Credit, the bank charges an excess amount as commission for its intermediary role in introducing the importer to the exporter and for ensuring the receipt of value upon arrival of the consignment.

This kind of banking activity, in which the bank takes commission for its services, is admissible by the Sharia. But what it receives as interest on the value it pays to the exporter after the arrival of the merchandise, owing to the non-availability of any fund from the buyer at that time, is interest, which Islam has forbidden.

Loans: It is common knowledge that loans occupy a special significance in banking activity. According to prevailing practice, the banks charge interest on loans, which has been forbidden in Islam. The Sharia declares it unlawful and calls it usurious interest.

The question arises as to what must be the most lawful form in which the profit of the

bank, as a financial establishment giving loans, should be combined with its disengagement from interest which Islam has forbidden.

Muslim theologians have considered the matter in depth and have come to the conclusion that the Sharia does not call for any freezing of banking activity. According to the precepts of Islam, the bank is a financial institution set up to advance necessary funds to people to play a productive role to bear losses accruing to the capital, with the exception of treason and any other harm caused by the bank's employees. In the case of profit, it is spread among the employees and the bank as agreed upon. Thus, it is possible to avoid the problem of interest. As a matter of fact, the bank is a financial machinery to help develop and rejuvenate the movement of production, commerce, agriculture and industry. It should render financial services to productive projects without any attempt at exploitation.

Remittances: When the bank sends a capital upon the orders of a remitter who has no account with the bank to which the capital is to be remitted, it takes commission for this transfer. Upon the sound pretext that the bank is not obliged to send the amount to the party to which the remitter advises the bank to send it, the acceptance of commission is permissible in Islam.

Also, when the bank assumes the position of a creditor to the remitter, it is not compelled to transfer any amount to the party to which the remitter asks the bank to send the remittance. But, since the bank does so, it can charge a special commission on this transfer. This kind of commission does not at all come in the category of forbidden interest.

Only Kodak Instant Cameras have a built-in flash!

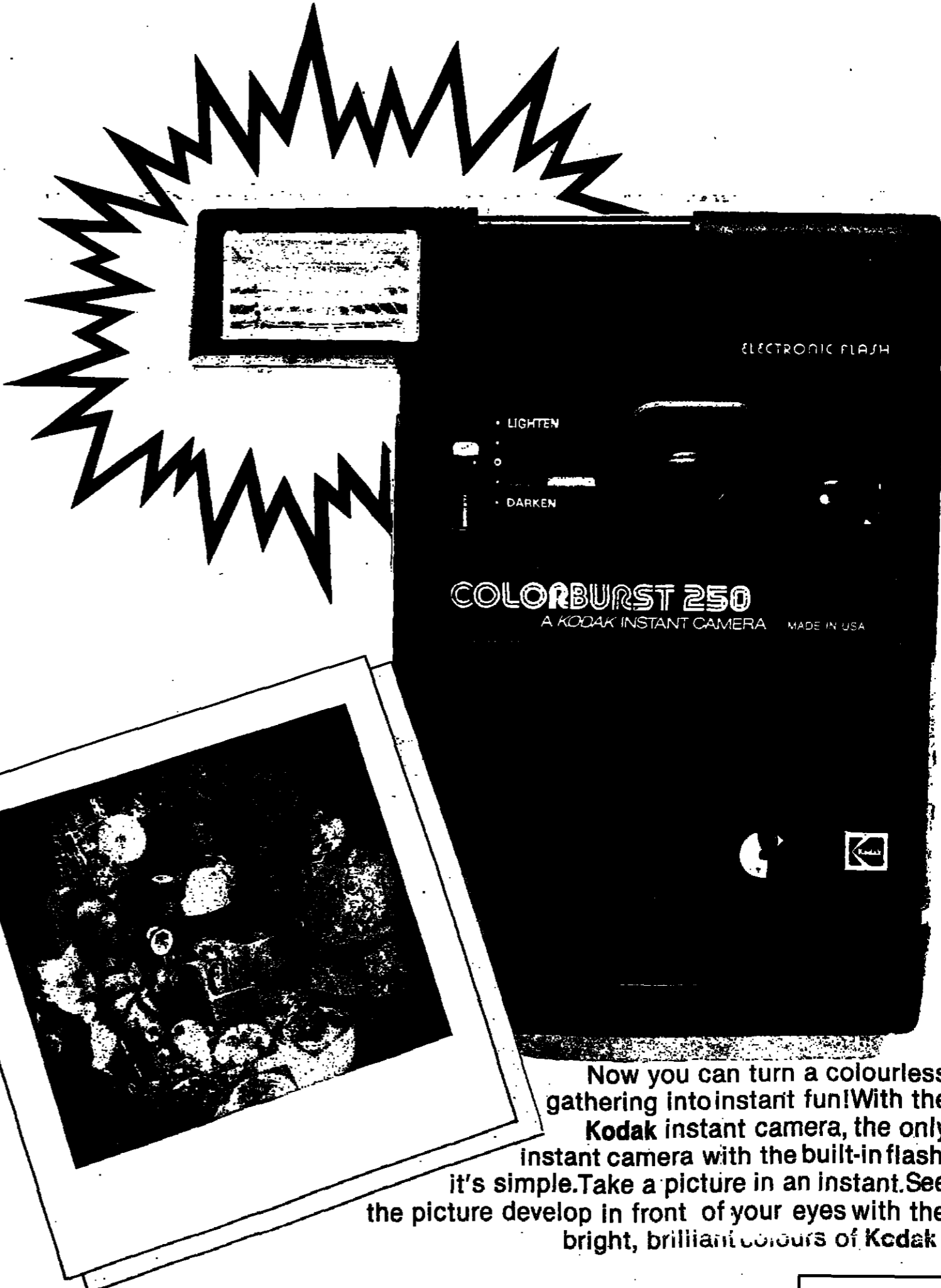

Now you can turn a colourless gathering into instant fun! With the Kodak instant camera, the only instant camera with the built-in flash, it's simple. Take a picture in an instant. See the picture develop in front of your eyes with the bright, brilliant colours of Kodak.

Instant Cameras by Kodak.



Agha Muhammad Ghose, assistant secretary general of the Islamic Chamber of Commerce, Industry and Commodity Exchange, population. Some of the active and dedicated members have made donations for meeting the budgetary expenses of the chamber.

The constitutional objectives of the Islamic Chamber signify the growing role it is destined to play in the future in order to fulfil the aspirations of the Islamic Ummah:

1. To encourage trade, industry, agriculture and handicrafts; to propose economic policies advantageous to its members and create avenues for collaboration among its members and similar organizations throughout the Islamic world in their efforts for economic development.
2. To encourage member countries to give preferential terms of trade to each other.
3. To promote investment opportunities and joint ventures in member countries.
4. To further develop cooperation in the fields of banking, insurance, reinsurance, shipping and other means of transportation within the Islamic world.
5. To provide for arbitration in the settlement of disputes arising out of commercial and industrial transactions.
6. To organize trade fairs, joint show rooms, exhibitions, seminars, etc.
7. To make recommendations to safeguard the economic and business interests of the Islamic world, and adopt collective measures which may include economic boycott against any party that commits aggression against any of the Islamic countries.
8. To strive toward the gradual realization of the Islamic economic community.

A priority and phased program was adopted by the executive committee of the chamber and subsequently by the first general assembly meeting held in Dakar, Senegal, in February, 1980.

The initial studies undertaken by the general secretariat of the chamber underlines the desire of the business community in the member countries to come forward and do their best in order to achieve visible results.

In some of its studies, the Islamic Chamber is closely collaborating with the OIC General Secretariat and thereby experts groups are jointly formed and activated. Close cooperation in working and research has also been developed with the Ankara Statistical Center and the Islamic Development Bank. The Islamic Chamber has also been invited for participation in seminars organized by U.N. agencies and the International Chamber of Commerce, Paris.

All the available studies relating to developing countries in general and Islamic countries in particular lead to the conclusion that the slow growth of trade among themselves is due to lack of proper and timely shipping facilities, inadequacy of trade financing instruments, and lack of production capabilities in the intermediate and engineering goods sectors. Therefore, the Islamic Chamber has directed itself to giving priority

SAUDI ARABIA'S FIRST ENGLISH LANGUAGE DAILY

arab news

SAUDI RESEARCH AND MARKETING COMPANY

THE ARAB NEWS IS A POLITICAL AND FINANCIAL NEWSPAPER

Chairman & Director General: HISHAM ALI HAFIZ
Editor in Chief: MOHAMMAD ALI HAFIZ

MAIN OFFICE: ARAB NEWS BUILDING OFF SHARARA, P.O. BOX 4558
TEL: 6534239 6534743 6533723 CABLE: MARADNEWS
TELEX: 401570 ARANEWS SJ JEDDAH

RYYADH OFFICE: AL BATHA STREET, AL RAJHI BUILDING NO. 2, 4th FLOOR,
APT. 210, P.O. BOX 478 TEL: 28272-30480-TELEX: 201660,
CABLE: ARABNEWS TELEX: 201660 MARAD SJ

EASTERN REGION OFFICE: ABDULLAH FOUAD CENTER ABDUL AZIZ STREET
10TH FLOOR SUITE 1003 AL-KHOBAR TEL: 8642991 8645678

MIDDLE EAST OFFICE: EGYPT: 31 JAZIRAT AL ARAB STREET, MADINAT
ALMOHANDASEEN, ADOUKI, CAIRO TEL: 818382 818121

LIBANON: SANAYAIN EL GHANEM BLDG., P.O. BOX: 8885 BERUT,
LEBANON TEL: 547080 TELEX: 20649

SUDAN OFFICE: KHARTOUM AL TAKAH BUILDING ATBARA STREET,
TEL: 717077/1782 P.O. BOX: KHARTOUM 2944

LONDON OFFICE: 67 GOUGH SQUARE FLEET STREET, LONDON EC4A 3D,
TEL: 353-44134548 TELEX: 882722 ARAB NEWS

EUROPEAN OFFICES: SWITZERLAND: 9 PLACE DU MOLAD, GENEVA,
SWITZERLAND, TEL: 211711 TELEX: 289005 SARF,
P.O. BOX 796 1211 GENEVA 3

PARIS OFFICES: 16, RUE CHRISTOPHE COLOMB, AVENUE GEORGE V
75008 PARIS 720 38 34 / 723 68 98

TUNISIA OFFICE: TEL: 258611

U.S. OFFICES: HOUSTON: 2100 WEST LOOP SOUTH, SUITE 1650 HOUSTON,
TEXAS 77027 TEL: (713) 961-0246 TELEX: 790209 ARABNEWS HOU

WASHINGTON, D.C.: 359 NATIONAL PRESS BUILDING
WASHINGTON, D.C. 20045 TEL: (202) 638-7183, TELEX: 440688 SAUDI UI

JAPAN OFFICE: BABA 2.12.10 TSURUMI, YOKOHAMA, JAPAN,
TEL: (045) 573-8816 TELEX J 47898 UMULQURA

GULF REGIONAL BUREAU:
Bahrain Tower Bldg. Manama Bahrain P.O. Box 20534 Tele: 232228

ANNUAL SUBSCRIPTION: SR 600
INTERNATIONAL: \$ 180 AIRMAIL POSTAGE INCLUDED

Produced and Printed at Al-Madina Printing and Publishing Co. Jeddah

SOLE ADVERTISING REPRESENTATIVES

TIHAMA

FOR ADVERTISING, PUBLIC RELATIONS & MARKETING RESEARCH

JEDDAH: Ministry of Foreign Affairs Circle, P.O. Box: 9455,
Tel: 6444444 (20 lines) Telex: 401205 TIHAMA S.J., Cable: TIHAMCO, Jeddah.

RYYADH: Ghoson Road, Royal Estate Co. Bldg., P.O. Box 4081,
Tel: 671400 (10 lines), Telex: 200910 S.J., Cable: TIHAMCO, Riyadh.

EL-QASEM: Barakid, Madina Road, Mashaqf Bldg., Apartment No. 606,
Tel: 69222200.

MECCA: Umm Al-Jood, Mecca-Jeddah Road, P.O. Box: 1974,
Tel: 655522, 6427067, 6427072, Cable: TIHAMCO Mecca.

TAIF: Al-Mudayna District, Airport Road, P.O. Box: 1246, Tel: 7288880.

DAMMAM: Al-Qadban Road, Bin Khaldoun District, Bughdan Bldg., 7th floor,
P.O. Box 2085, Tel: 833255, 8320434, 8333352, 8333384,
Cable: TIHAMCO, Dammam.

OUTSTATION ADV. SERVICES: Jeddah, Hama Bin Thabit St., Al-Bughdanlyah,
Tel: 642088, 642092, 642095.

ADHA: Al-Nasr Domestic, Taif Road, P.O. Box: 522,
Tel: 2942571, 2948110, 2948804, Cable: TIHAMCO, Adha.

LONDON: International Press Centre, 76 Shoe Lane, EC4A 3JL,
Tel: 012528525, 01252853, 012528124, 012528140, Telex: 28522 TIHAMA G,
Cable: TIHAMCO, London.



Carter may abandon home town

By Thomas Greenwood

WASHINGTON — No one can know President Jimmy Carter's thoughts as he prepares to yield the leadership of the Western world to Ronald Reagan, but sources close to the White House say the first family is not overjoyed at the prospect of returning to life in his minute home town of Plains, Georgia—population 700—despite enthusiastic "welcome home" letters from the local women's clubs.

It is apparently a question of how one can keep them down on the farm after they've seen Patee. The Carters will abandon Plains for the less provincial haunts of Atlanta—135 miles away—within a few months after Carter leaves the White House, according to reliable reports. Carter's office and presidential library will be in Atlanta, a moderately liberal enclave in the conservative deep South.

But the people of Plains have either not heard or not yet accepted the news. The clerks in the souvenir shops and attendants at the filling stations along Plains short main street, and even the president's cousin Hugh, are adamant that "Jimmy is coming home to stay." They have reason to spread the word, however, misleading, because the tourist trade which transformed Plains from an obscure backwater into a national shrine after Carter's victory in 1976 has all but dried up. The people of Plains want Jimmy Carter to become another roadside attraction.

"People want to see a president," said cousin Hugh from behind the counter of his souvenir shop. "Thirty-five million people voted for him. There are a lot of people that like Jimmy Carter."

Word was out recently that the president would be in Plains but even so the streets—totally congested with sightseers a couple of years ago—were nearly empty. So were the "Peanut Patch," "Peanut Museum" and "Peanut Gallery" all advertised on billboards for miles around.

Jimmy Carter trinkets, such as one which uncaps bottles with replicas of the presidential teeth, went begging. Cousin Hugh's book about the secrets of the Carter clan was marked down \$3 to \$7.95.

Yet with the president in Atlanta, and tourism on the wane, Plains will still be able to look to two gifts of the Carter years—the first traffic light in the hamlet's history and a shrub garden donated by the government of Taiwan and not taken back despite Carter's continued tilt toward Peking.

A question of interpretation

By Mark Frankland

LONDON — Hardline ideologists in East Europe are using the crisis in Poland as an excuse for a triumphant re-statement of their own narrow interpretation of Marxism-Leninism. Their message is simple: those who, like the Poles, stray from this one and only correct interpretation will be faced with at best confusion, and worst counter-revolution.

The Czechoslovak press is now giving the impression that the Polish Communist Party—although belatedly—now understands this essential truth. Prague radio reported that in a meeting last month with journalists from Warsaw Pact countries the head of the ideological department of the Polish Communist Party Central Committee admitted that ideological work in the past 10 years had been unsatisfactory, and that the Polish party would now rely on the principles of Marxism-Leninism and the experiences of Soviet Communists and other fraternal parties.

These ideologists say that nothing less than an alteration of "the consciousness of the masses" is necessary if socialism is to win "lasting victory."

Vasil Bilak, Prague's leading ideologist, put this thought in a particularly striking way earlier last year: "Even if we were drowning in luxuries and had all our desires filled we could not let up on ideological work and education of Socialist man, for we would only breed a new middle class, a Socialist variety, far worse than the one we are still surmounting."

According to this way of thinking a man is only truly Socialist if he finds perfect freedom in following the orders of the Communist Party. Any other sort of citizen is liable to be seized by all sorts of ideological illnesses such as petty bourgeois ideas and thinking; nationalism; anti-socialism; cosmopolitanism; and, last but certainly not least, relig-

On reviving East Africa common market

By Nick Worrall

NAIROBI — Dr. Milton Obote's return to power in Uganda has led to hopes of an improvement in relations with the country's neighbors, Kenya and Tanzania and even the possibility of reviving the defunct East African common market. Since his controversial win in Uganda's first elections for 18 years, the 55-year-old Obote has received instant recognition from all Uganda's neighbors, despite the reservations of some in the months of unrest that led to his comeback.

Obote has several times in recent weeks hinted that he would like to restore the East African community that he helped to set up and which died in 1977 of ideological wrangling and African chauvinism.

Certainly, Obote holds the key to improved relations between Kenya and Tanzania, which have been frigid since the latter closed its borders to Kenyan trade and tourist traffic in February 1977. Tanzania's President Nyerere harbored Obote for his nine years in exile and used his armed forces to drive out Idi Amin. No doubt Obote's election victory, however it was achieved, has brought great satisfaction to Nyerere.

In turn, Kenya's President Moi has swallowed distrust of Obote and his socialism and has expressed the hope that "your triumph will bring with it political stability and maintenance of law and order in Uganda, so that a new climate conducive to meaningful reconstruction and development can now reign."

If it is true that relations between Uganda and Kenya can be stabilized, then the way is open for Obote to bring together all three East African leaders at a time when they all face increasingly hard times, brought on by rising oil prices, food shortages, falling exports and worldwide recession.

It is well known that Uganda will have to start from bare beginnings to revive its once highly profitable coffee, tea, sugar, cotton and mineral earnings.

Kenya's balance of payments surplus at the beginning of last year of more than \$200 million has plummeted to a deficit exceeding \$240 million in early December.

Tanzania's economy is in trouble, too, and it seems on balance a good time for East Africa to think regionally again.

DECISIVE WEEK

Dealings between Tehran and Washington over the American hostages held in Iran are entering a decisive phase. By next week, President-elect Reagan will take his oath of office and enter the White House to start his four-year term of office. He has already given notice that he will not simply continue with the process over the hostages initiated by the Carter administration.

The indications are that his stand will be a tough one: he might consider the hostages "prisoners of war" and treat the matter from a completely new angle. In this case, Iran would lose what it always took to be its strongest card against the United States. It would also deny itself, perhaps for a long time, those urgently needed funds which are frozen in the United States.

This explains the note of urgency over a speedy solution for the problem in Iran's more recent utterances on the subject; as well as that of realism in its expectations of the American *quid pro quo*.

Iran has estimated its assets in the United States at \$14 billion, as against an American estimate of no more than \$7 billion. The American also deny any exact knowledge of the amounts held privately by the former Shah and his immediate family in American banks. But they indicate that Iran's estimates of it are grossly exaggerated.

In any case, Iran realizes now that time is no longer on its side, and that if no solution was found this week, the whole game will return to square-one.

POLAND'S DILEMMA

Thirty years after the Communist takeover in Poland, 70 per cent of its agricultural land is still in private hands. Polish farmers moreover have retained their distance from the Communist rulers and their cooperative agricultural ventures. It is therefore no wonder that the Polish government looks at the growing movement for a national farmers' union with the utmost apprehension.

The Polish government was reluctant enough to grant such a right to the country's workers. It did so only in the knowledge that state ownership of factories would give it the upper hand in the end in any future confrontation. In the farmers' case, such a consideration does not arise. They are as independent an economic force as they are a political and ideological one. A farmers' union would be automatically a point of mobilization for the country's large rural population. In all but name it would become a vast political party standing against the Communists.

Polish Communist leader Kania faces therefore a most painful dilemma. On the one hand, the pressure of events is such that the farmers' fight for a union is bound to succeed. On the other, its success, more so than in the case of the workers' unions, would pose a direct threat to the monopoly of power by the Communists. In fact it would amount to establishing a multi-party system in the country, one in which one of the strongest parties, that of the farmers, would be able to forge ahead without the need to form alliances and work out compromises with any other party.

Letters to the editor

ARAB NEWS welcomes letters from the readers. The letters, preferably typed and having full address, may be edited for space and clarity. They should be addressed to:

**THE LETTERS EDITOR,
ARAB NEWS,
P.O. BOX 4556
JEDDAH, SAUDI ARABIA**

Saudi Arabian Press Review

radical solutions could be found to all the problems of the Islamic world. It also gave prominence to the Kingdom's ceaseless efforts in convening the summit and the role of Islamic states to raise the level of their peoples in every sphere.

Al-Yom said there could be no doubt about the historical value of the summit, as everyone has started feeling the magnificence of the meeting at Mecca. The paper added that the unanimous response to King Khaled's invitation is the outcome of the monarch's deep concern for the conditions of Muslims everywhere and his sincere efforts to overcome all the obstacles coming in the way of Islam. It further reiterated that the summit would be held not only for welfare of Muslims but for the welfare of humanity at large.

In an editorial, *Al-Madina* observed that the sentiments King Khaled have expressed Tuesday toward the summit mirror the aspirations of every Muslim at this juncture when the 15th century of the Islamic calendar has just begun. The paper said it was nothing strange if the monarch's invitation received a favorable response from Muslim leaders, for they believe in the significance of this meeting through which they could serve their faith and keep aloft the word of God. The optimism expressed by the King confirms the reality that meetings among Muslim brothers must always rise above differences, for the basic object of meeting is to serve Islam and to reinforce Islamic solidarity.

Al-Bilad reiterated that the Saudi Arabian leadership has provided all possible elements for the success of the summit. It said the Kingdom derives its strength from the solidarity of Muslims and an Islamic strategy for a united action to solve their common problems. The paper referred to the foreign minister's press conference Tuesday, in which he emphasized cooperation among all the Islamic states, so that

also strive to reinforce economic cooperation among the Islamic states and to amend the charter of the Secretariat General of the Organization of Islamic Conference (OIC). It urged the need for eliminating mutual rifts so that it could be possible for the Islamic world to tackle its issues successfully. The paper reiterated that the Islamic nation looked forward to the summit with great hopes and aspirations.



From American history

Author captures folk heroes

By Holle L. West

WASHINGTON (WP) — Justin Kaplan, who's just published a critically acclaimed biography of Walt Whitman, smiles faintly — and a little mockingly — when recalling the intimidating stares of several scholars while working on his first book, the Pulitzer-Prize-winning biography of Mark Twain.

He remembers it as a risky venture, stepping into the Mark Twain collection at the University of California at Berkeley.

"There was a room full of scholars, he says in an evenly paced nasal tone. They looked at me as if I were some sort of misplaced apparition. Some of the people made me feel uncomfortable, but really the good people in the field were wonderfully hospitable."

Kaplan has received almost unanimous praise for his biography of Whitman, frequently called the greatest American poet, the writer whose very life was considered a grandiose poem.

Saturday Review called the book a "delicate, calm and painstaking biography." The Washington Post deemed it "a handsome narrative, invariably fluent and intelligent." And from The New York Times: "Justin Kaplan's taste is very nearly impeccable, and by his emphasis and omissions a critical view of Whitman's best work is silently conveyed and Kaplan's human insight makes psychological connections that illuminate, often by delicate juxtapositions of texts, a whole tract of poetry."

On the strength of his previous two biographies — of Twain and journalist Lincoln Steffens — Kaplan already was considered a major American biographer, master of a form that is gaining wider literary recognition.

After undergraduate and graduate work at Harvard, he worked as a freelance editor in New York and at one time assisted anthologist Louis Untermeyer. He thought he'd like to write books, maybe history. But he wasn't sure.

"One day I was having lunch with a close friend and a mentor," he recalls. "He said, 'Why don't you write a book about Mark Twain?' It never would've occurred to me in a million years to write a book about Mark Twain. But somehow there was some electric response."

"I find biography a congenial form. It's ideal. I really want to stick with it. I've been asked to do various kinds of histories. I really don't want to do that. I like writing about people."

Kaplan grew up reading about people. He remembers his father, a shirt manufacturer who really wanted to be a scholar, doing a lot of reading. "I was brought up on Tolstoy and Boswell's 'Life of Johnson' and Pepps' Diary," he says, smiling contentedly. "And for a while I hated both Johnson and Pepps because they had been hauled at me throughout my childhood."

His mother died when he was eight and his father died six years later. "It's been so long since I had parents that that I tend to think I never had any parents," he says. "I was lucky because I was brought up by two people: my brother, who was nine years older than me; he died last year and he's the one to whom the Whitman book is dedicated, and then a West Indian woman who had come to work for my mother when I was about a month old and who has really brought me up. She lives in New York now. I see her often."

"I think of myself as a professional orphan. My father left me with enough money so that I could go to college and do a certain amount of traveling and not have to worry right away about a paying career."

So after college and some travel in Europe, he tried his luck in the New York publishing world, going from publishing house to pub-

lishing house on a freelance basis. After settling in at Simon and Schuster, he became editor for Bertrand Russell, Will Durant and Nikos Kazantzakis.

For the last 21 years, Kaplan has lived in Cambridge, Mass., with his wife of 26 years, Anne Bernays, also an author who's written six novels. They have three daughters, aged 23, 21 and 18.

Kaplan has just started researching a biography of Ulysses S. Grant, and he already emits a glow while talking about his Grant project.

"He's very much like Whitman and Mark Twain," he says. "There's something in the lives of these three people that you could only describe as the quality of theological grace, that is, something very big is happening to them. Their successes are larger than the success of normal people. Their failures are horrible failures. Mark Twain goes bankrupt. Grant goes bankrupt."

But there was something redemptive in Grant's life, Kaplan says. Near the end of his life he quickly wrote his memoirs in what Kaplan described as a "marvelous prose style." After Grant's death, Twain arranged to have them published and the big contract for the book lifted the Grant family out of bankruptcy and assured them of financial security.

Though he's working on Grant now, Kaplan hasn't put Whitman in the background yet. He likes to think of how the poet still speaks to contemporary Americans — through his own poetry and that of poets like Allen Ginsberg and the late Frank O'Hara.

"I think Whitman, the subject, is somehow very timely and very immediate," says Kaplan, "and people are just beginning to realize that he is really a major American figure. There are certain moving things about his life, which could move a lot of other people — a sense of potential and possibility in the most ordinary or mediocre lives."

"The whole Whitman background — or foreground — appears to be unpromising. He's a carpenter, a school teacher, an okay journalist, but he really doesn't have the persistence. He runs a stationery store for a

Doctor warns against fetal monitoring

By Philip J. Hills

TORONTO (WP) — Virtually all the hospitals that use machines to monitor fetal heartbeats are doing it wrong, according to a new study by Dr. John Patrick of the University of Western Ontario.

Furthermore, Dr. Patrick said, the fetal monitoring machines were in widespread use in hospitals eight years before the first study of their value was even begun. "No one should have installed these machines until they knew whether they were of any value — because there are risks involved. And also they should know what the measurements on the machines mean before using them — and doctors didn't then and still don't now."

There are now between 30 and 50 per cent false positive results in the use of fetal monitors, Patrick said, and that means many babies are delivered using emergency procedures, such as caesarian operations, when no such emergency action is necessary.

Though most babies and mothers are not hurt as a result of the mistakes, a small percentage of such emergency procedures result in injury or death.

The fetal monitoring machines are used before and during labor to monitor heartbeats and fetal movement. If either or both are abnormal, emergency measures to remove the baby from the womb or change its position within the womb may be taken.

If a fetus' heartbeats are monitored at



WHALE PERFORMANCE: After extensive training, a killer whale, called Shamu, has been taught to thrust its keeper high into the air. The powerful animal, weighing four tonnes, appears to enjoy the act as much as the audience at the Sea World in Florida.

while. He moves from job to job. And then suddenly at the age of 34, something remarkable happens to him.

"Before then he's written very conventional poetry. Suddenly he knows what he was born for and begins to write truly remarkable and original poetry. You can talk about this change in terms of ecstatic experi-

ence or some kind of illumination. But I think it's still relevant to anyone.

"What it suggests is that there are whole uncapped reservoirs of creativity in the most unlikely people. He respects what happened to him as a kind of sacred mystery. And I do, too, because you can't find it. Finally, all you can say about it is that it happened."

Arab News Diary

JEDDAH

By Rasna Siddiqi

THE MIDDLE EAST construction exhibition will be inaugurated Thursday, January 15, by Mecca Governor Prince Majed at the Al-Hazhzi exhibition center at 7 p.m. Building materials of all sorts will be put on display by leading world companies at the exhibition.

KOMATSU DISTRIBUTORS from Middle East countries, including the U.A.E., Iraq, Jordan, Sudan and Oman, were in Jeddah to attend a two-day seminar held January 13-14 at the Sheraton Hotel. The subject of the seminar was hydraulic excavators which were introduced to the Saudi market last November. A large number of people attended the seminar.

PAKISTAN EMBASSY BAZAAR in aid of the Pakistani School will be held Thursday, January 15, at the Pakistani Embassy. On sale will be spicy food, exotic clothes, and exquisite handicrafts. A special treat will be the application of henna on your hands (if you so wish) in intricate designs by experts in the art. There will be games for children galore. Doors open at 3 p.m.

THE NEW TERM of the Continental adult college of education begins Saturday, January 24. Separate courses for men and women include Arabic, English and French and such interesting subjects as pottery making, yoga, karate, guitar playing and the very useful subject of typing. Registration begins January 17 and will continue through January 20.

AL FAISALIYAH WOMEN'S WELFARE SOCIETY will present a program featuring the well known local singer Etah Monday, January 19, at the Meridien Hotel. The program includes sale of food and begins at 9 p.m.

BRITISH BUSINESSMEN'S LUNCH is scheduled for 1 p.m. at the Nova Park Hotel Sunday, January, 18.

AUDITIONS for the next S.E.T. production of Three Sisters will be held January 17 and 18 at 8 p.m. at PCS. The program will be presented in March.

EASTERN PROVINCE

By Jean Grant

OFF RUNWAY PLAYERS will present Neil Simon's Come Blow Your Horn at the Hochstet Compound by Jeddah's new international airport. The three-act comedy will run from Jan. 27 through 30, and tickets cost SR20. The tickets may be picked up at the door, or at PCS by contacting Mrs. Vinyard. Ergin Kok is producer and director for the performance.

CERAMICS WILL BE discussed and demonstrated during the Jeddah Fine Arts Society's next meeting at 7:30 p.m. Monday, Jan. 19. The public is invited to attend the get-together at USGS recreational villa. You too can be a master of your plaster.

THE AL KHOBAR PALACE HOTEL was the setting for a traditional Saudi-style wedding between Muhammad Al-Gaidany and Fawzia Al-Karry last Thursday, Jan. 8. Many

Westerners were among the 500 guests who celebrated the happy occasion. American consul-general James Ealun; Don Keye, general manager of Tamimi and Foudad Construction; Alfred Bazali of Telemedia and Bob Eberhart attended the men's party with Prince Turki from the Ministry of Agriculture; Abdullah Al-Afandi, Abdullah Rashid and Abdullah Moharib.

Meanwhile on the fourth floor, the ladies were having a grand time listening to the rhythms of a talented group of seven musicians. Veiled in the Bugra, they beat the drum and tambourine and sang. Incense was passed around on smoking braziers and a feast was consumed before the entrance of bride and groom. Family and a throng of well-wishers warmly congratulated the newly-weds who were seated upon thrones on a gaily-decorated dais. The bride was radiant in a western bridal gown with a beautiful lace veil.

Two American touches were added as guests threw rice (hidden in roses made by Naida Lawrence) at the newly-weds and the bridal car was festooned with a trail of confetti and a Just Married sign. In a couple of weeks the bridal couple will honeymoon in Abha.

MANY ART ENTHUSIASTS are hoping Enza Qargnali will treat them with a show, so they can admire her like the Romans did. The artist is back in Dhahran after a vermissage of soft sculpture at the Galleria Dei Baffi in Rome. The talented Aramco artist fashioned flowers and other plant forms in silk, cottons, linen and other textiles.

LOCKHEED EMPLOYEES are going in for bowling in a big way these days. The company, one of the oldest in the area, has six teams in its own league. Plans already are underway for a bowlers banquet in May.



A Jeddah mosque

SHIBAURA

IHI-SHIBAURA PORTABLE GENERATOR

Wide scope of applications any time, anywhere!

Super compact supplier of electric power for illumination, construction agricultural work, home usage, and emergency use

Supplying gasoline engine generator from 400 Watts to 3500 Watts, AC or AC & DC.

Diesel engine generators are supplied from 2000 Watts to 7500 Watts. Heavy duty and economical power source.

For further information please contact:

A.M. BAMAROUF

Riyadh (01) 402-0633 P.O. Box 3728
 Dammam: (03) 832-2609 Tel. 6435610 / 6433016
 Taif: (02) 732-1478 Telex 401882 MAROUF SJ
 Khemis Mushat: (07223) 9872 Jeddah, Saudi Arabia

An Exhibition of the ten most famous French artists

EMILE COURTIN • NICOLE ANDRE' • PIERRE BAUDIN
 RAYMOND SOLARI • ALAIN DURAFFOURD • JAQUELINE GOUGIS
 POUCEITE • JEAN-LOUIS FILOCHE
 ROBERT ANTOINE • MANVEL GARGALEIRO

10th - 20th JANUARY

REDEC PLAZA MEDINA ROAD JEDDAH.
 TELEPHONE 6447476/69 OPEN FROM 10AM - 1PM, 5PM - 10PM

REDEC PLAZA GALLERY

Leader in Kampuchea

Son Sann to set up provisional rule

SOKH SANN VILLAGE, Kampuchea, Jan. 14 (Agencies) — Son Sann, leader of Kampuchea's main non-Communist guerrilla movement, has said he will form a provisional government before the United Nations General Assembly meets next autumn.

Son Sann, 70, made the announcement to several thousand followers here Tuesday after an exhausting trek from Thailand over a mountainous terrain. He received a ceremonial and emotional welcome from people with otherwise little to celebrate.

Son Sann, who was once Kampuchean premier under former head of state Prince Norodom Sihanouk, heads the Khmer People's National Liberation Front (KPNLF) which opposes both the Vietnamese-backed Heng Samrin government and the approximately 40,000 guerrillas of the ousted Khmer Rouge administration.

The KPNLF claims control of several hundred thousand civilians in camps along the Thai-Kampuchean border and villages in western Kampuchea as well as several thousand guerrillas. Son Sann, who lives in Paris, has been named by some leaders in the Association of South East Asian Nations (ASEAN) as possible head of a "third front" against both the Vietnamese occupation force and the Khmer Rouge.

He said he had received political support from some ASEAN members — Indonesia, Malaysia, the Philippines, Singapore and Thailand — but hoped for material aid. However, he said, that the KPNLF could not be described as a third front, only as the representative of all Kampuchean patriots.

Son Sann said he had discussed forming a provisional government with leaders of several countries and was awaiting the right moment.

North Korean premier ends talks with Zhao

PEKING, Jan. 14 (AFP) — North Korean Premier Li Jong Ok left here Wednesday for Burma after a four-day visit during which he had talks with his Communist Chinese counterpart Zhao Ziyang. New China News Agency said that before his departure, Li had had a last meeting with Zhao and added that the two men had expressed satisfaction with the "fruitful results" of their talks.

Diplomatic sources said the talks touched

on bilateral economic ties and probably on the latest South Korean initiative for a dialogue with the Communist North Korean regime. South Korean President Chun Doo-Hwan has invited his North Korean opposite number Kim Il-sung to visit Seoul for talks on the reunification of the divided Korean peninsula.

Communist China backs the North Korean regime and fought on its side during the Korean war. Peking has also supported the Pyongyang proposal of a federation of North and South Korea. While speaking out against the South Korean regime from time to time — a regime it does not recognise — Communist China is relatively moderate in its criticism of the presence of U.S. forces in South Korea.

Carter to make speech

WASHINGTON, Jan. 14 (AP) — President Jimmy Carter will deliver his farewell address to the nation Wednesday night from the Oval Office at 9 p.m. (0200 GMT Thursday). The White House said it would last 20 minutes.

White House aides termed the address as a look forward at the challenges that will face the American people after Carter leaves office. They predicted it would be a personal statement, emphasizing his concerns for world peace and other global issues.

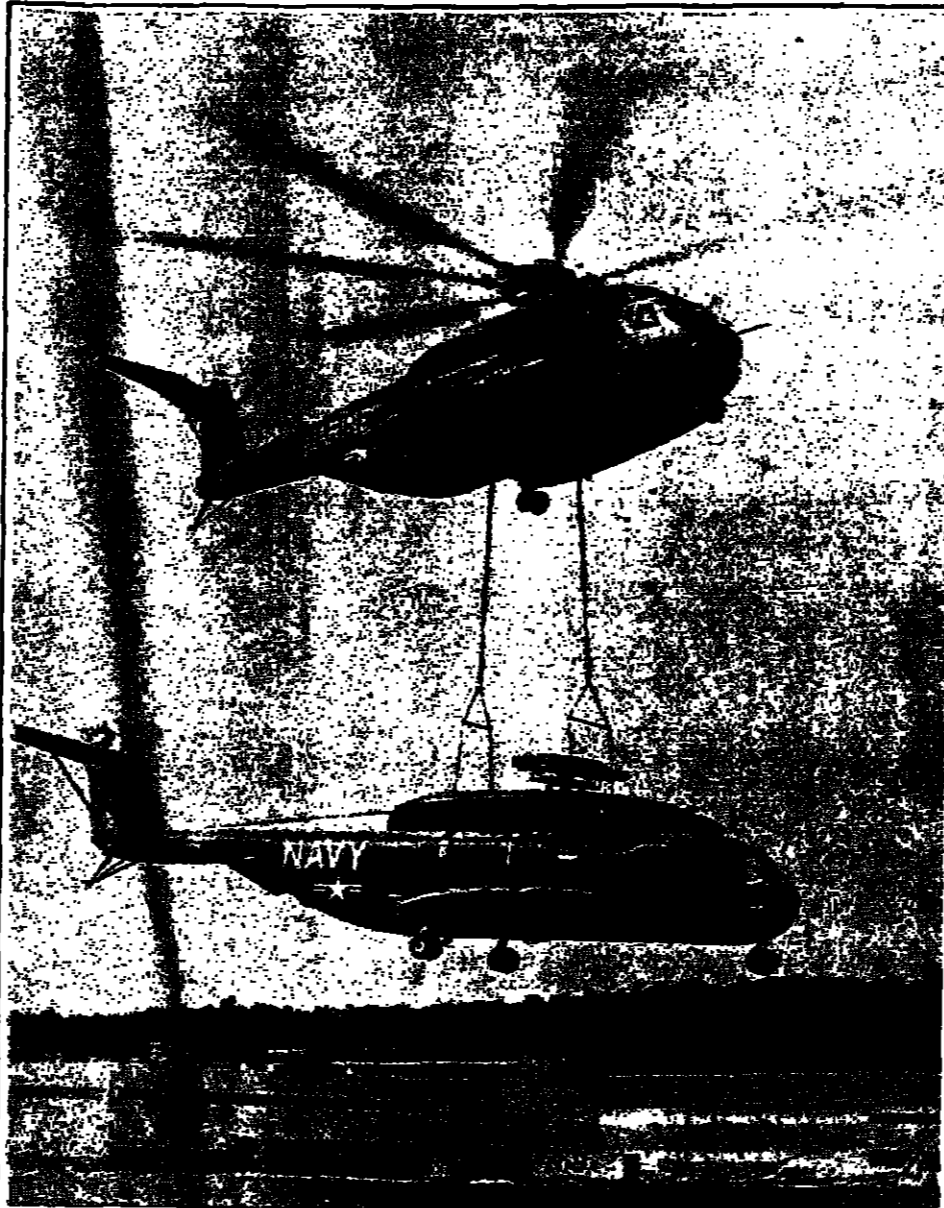

HELICOPTER LIFTS HELICOPTER: Demonstrating its immense lifting capability, a super Stallion CH-53E helicopter lifts an earlier model prototype. The test operation at a U.S. airfield shows the lift capacity of the helicopter. The combined gross weight of the two aircraft is 31,500 kilos.

Rival Salisbury guerrillas clash

SALISBURY, Jan. 14 (R) — Four people were injured in shooting and grenade attacks in Salisbury's restive Chitungwiza township where rival guerrillas were quartered, police said. The violence, which occurred in the last two days, was the first incident since Joshua Nkomo, head of a guerrilla force, was demoted in a cabinet reshuffle last weekend.

Government sources blamed Nkomo's ZIPRA (Zimbabwe People's Revolutionary Army).

Meanwhile, officials of Nkomo's minority PF-ZAPU party said a central committee session to decide whether he should accept his demotion from Home Affairs Minister to Public Service Minister had been delayed.

U.S. extends temperature controls

WASHINGTON, Jan. 14 (AP) — President Carter, citing precarious world oil supplies, has extended for another nine months the mandatory U.S. government temperature controls for 2.8 million offices, shops and other non-residential buildings in the U.S.

Under Carter's order, the thermostat controls would remain in effect until Oct. 16. President-elect Ronald Reagan, who has voiced opposition to government-required conservation measures, could reverse the action as soon as he takes office, however.

Watergate break-in immoral, illegal — Haig

WASHINGTON, Jan. 14 (R) — Secretary of State-designate Alexander Haig says he will not pass moral judgment on Richard Nixon whom he served as White House Chief of Staff at the height of the Watergate scandal.

He set out his views Tuesday at a Senate hearing into his nomination after he had exploded in anger at what he apparently saw as an inference that he acted improperly in the Nixon White House. In an exchange with Democratic Senator Paul Sarbanes of Maryland, Haig repeatedly refused to say whether controversial actions taken during the Nixon administration were right or wrong.

But, during a break in the Foreign Relations Committee hearing, he evidently conferred with his counsel, former cabinet official Joseph Califano, about the impression he might have left.

When he returned, he said of the Watergate break-in and subsequent cover-up: "Those actions were improper, illegal and immoral. They were an affront to the funda-

mental values which I cherish, and we all share."

But he added: "I cannot bring myself to render a judgment on Richard Nixon or, for that matter, Henry Kissinger. I worked intimately for both men. It is not for me — it is not in me — to render moral judgments on them."

Haig had told the committee earlier: "I never willingly consciously or unconsciously participated in an act which I considered to be immoral or at all illegal." His voice rose to a shout when Sarbanes tried to pursue the issue to his role during the Watergate period. "I'm somewhat surprised at your persistence on this subject in the light of questions I have answered repeatedly in three days before this committee," he said.

While condemning the Watergate bugging and cover-up scandal, Haig made it plain that he fully supported the secret bombing of Kampuchean sanctuaries during the Vietnam war and the 1972 Christmas bombing of North Vietnam. Those actions, he said, were not abuses of power.

Europe reels under snow; several deaths reported

PARIS, Jan. 14 (AP) — Heavy snow and freezing temperatures in Europe this week have caused a number of deaths as several nations in the continent experienced one of the harshest winters in recent years. One of the hardest hit areas has been France. Parisians were surprised Monday night with a snow storm, a rare occurrence. Record demands for electricity and downed power lines have left six of France's 90 department stores without any electricity, and officials were doubtful whether the electricity could be restored before the weekend.

The heavy snow boosted business in Alpine resort towns in France, Italy, West Germany and Austria. But the welcomed snow, at the resorts, also was deadly. Avalanches after heavy snowfalls in France have killed nearly two dozen people.

In Greece, where January is traditionally a mild month, the chilling weather has caused several deaths, besides causing severe damage to citrus and olive crops. Snow blanketed northern Italy Tuesday, ending an unusual two-month dry spell.

Near Naples, tens of thousands of Italians left homeless by the massive Nov. 23 earthquake, have struggled with snow and icy rain that have pelted southern Italy for five consecutive days. More than 140,000 of the homeless still live in temporary settlements such as tents, campers and railway cars, after refusing "relocation" to government-

requisitioned hotel rooms and villas away from their towns and villages. The wintery blasts have crossed the Mediterranean sea to North Africa, where Tunisia recorded its heaviest snowfall in a century.

Armed rustlers loot in Uganda

KAMPALA, Jan. 14 (AFP) — Armed gang of rustlers have left a trail of blood, looting and burning houses in a new wave of cattle raids in the famine-ravaged Karamoja region, the official Uganda Times has said here. The gangs had hit villages in five different counties in northeastern Uganda since the start of the year, the newspaper said.

It also reported military indiscipline in the region with some government militiamen posted along certain borders of Karamoja province turning their guns against tribes they were supposed to protect.

A total of 15,000 militiamen were posted along the province's southern and western flanks last August to prevent the raiders spilling outside the province.

It was not immediately clear whether the renewed cattle raids posed any serious threat to international relief workers in the famine-stricken area. The relief workers mainly hail from France, Britain and the U.S.

PENTAX DOUBLE SHOOT

SHAMSUDDIN ASHRAF
P.O. BOX 235 AL-KHOBAR TEL. 5641

The success and reliability of the Mirreles Blackstone E type add up to just one thing.

The ESL Mk2

In the 30 years since it was introduced more than 8000 Blackstone E Type diesel engines have been commissioned for marine and industrial duties in all parts of the world.

Based upon the wealth of operational experience from these engines an extensive research and development programme now brings an addition to the range in the ESL Mk2, a design incorporating many parts which are interchangeable with existing E Type engines. Featuring an improved power/weight ratio and economical fuel consumption the ESL Mk2 is available in 6 and 8 cylinder units with outputs of 980 and 1310 bhp respectively at 900 rev/min. giving generating set outputs of 683 kW for the ESL6 Mk2 and 917 kW for the ESL8 Mk2 at 60 Hz.

Important refinements include 4-valve cylinder heads, oil cooled pistons, externally mounted fuel pumps, separation of lubricant and fuel oil, higher strength gears and choice of wet or dry sump. All engines in the range are turbocharged and intercooled.

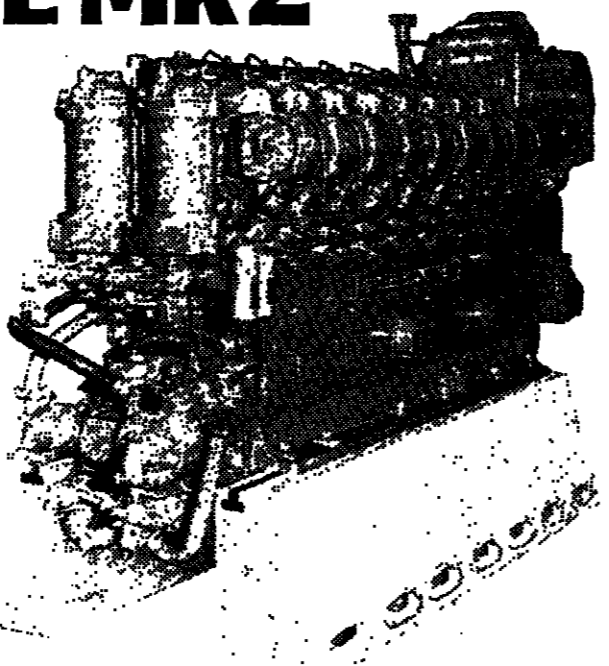

A wide range of installations are operational in Saudi Arabia and a factory trained service engineer and stocks of spares are located in Riyadh.

Our resident sales engineer is available for on the spot information and advice c/o our Saudi Arabian agents:

Ahmad Hamad Algosaihi & Brothers,
PO Box 74, Riyadh.
Telephone 4025352
Telex 201309 GORYAD SJ
with additional Offices in Al Khobar and Jeddah.

See the ESL Mk2 generating set on the Hawker Siddeley stand no.124 at the Middle East Electricity Exhibition in Jeddah, 28 February — 5 March 1981

HAWKER SIDDELEY
MIRRELES BLACKSTONE DIESELS

MIRRELES BLACKSTONE (STANFORD) LIMITED, STANFORD, LINCOLNSHIRE, ENGLAND.
Telephone: 0780 4841 Telex: 32234.

Hawker Siddeley Group manufactures electrical and mechanical equipment with world-wide sales and service.

SAUDI BUSINESS ON SAUDI OIL

(An inside look at the Saudi Oil industry and its impact on the 80s)
ISSUE DATE: March 7, 1981
(Plus distribution at the 1981 Offshore Technology Conference)
AD CLOSING: February 4, 1981

Saudi Arabia and oil. You hear a lot about both, but always from the outside looking in. Now Saudi Arabia's only weekly 4-color business magazine will give you an inside look at the most important market in the global oil community.

The March 7, 1981 issue of SAUDI BUSINESS & ARAB ECONOMIC REPORT will examine the growth and development of the Saudi oil industry and its impact on the 80s.

This issue is timed to coincide with the largest oil exhibition in the Middle East—The Middle East Oil Show, March 9-12, in Bahrain. Last year, roughly 329 oil industry executives/manufacturers attended U.S. oil shows, while 6,315 attended the Middle East Oil Show.

By advertising in SAUDI BUSINESS you have an opportunity to display your goods and services to these same Middle East executives.

TWO ADS FOR THE PRICE OF ONE—AN ADDED BONUS FOR OTC EXHIBITORS

The same Saudi Oil issue that is distributed prior to the Middle East Oil Show will be reissued and distributed at the 1981 Offshore Technology Conference, May 4-7, 1981 in Houston, Texas.

Thus you'll pay for one ad, but your ad will run twice. Use your ad to advertise your booth number both at the Middle East Oil Show and at OTC.

YOUR SAUDI BUSINESS REPRESENTATIVE

For more information about advertising in SAUDI BUSINESS ON SAUDI OIL, please contact:

In the U.S. and Canada:
SAUDI RESEARCH & MARKETING, INC.
2100 West Loop South, Suite 1650
Houston, Texas 77027
Tel: (713) 961-0245 Telex: 790209 ARAB NEWS HOI



In Saudi Arabia:
TIHAMA
P.O. Box 5455
Jeddah, Saudi Arabia
Tel: 40000-20 lines
Telex: 401205 TIHAMA SJ



In the United Kingdom:
TIHAMA
76 Shoe Lane
London EC 4A 3JB
Tel: 01/353-8899
Telex: 28522 TIHAMA G

Leadership in publishing and communications since 1937

In an era of vulnerability Intelligence data vital, Casey says

WASHINGTON, Jan. 14 (Special) — President-elect Reagan's intended Director of Central Intelligence says that effective intelligence is far more important in an era of military vulnerability than it may have been some years ago when we had clear military superiority.

In a confirmation hearing Tuesday before the Senate Intelligence Committee William J. Casey pledged to provide police makers "in the Congress as well as the executive branch" with "timely and accurate" intelligence information.

He said they will be able to rely on it in establishing "the defensive strength that we need, in seeking arms control, in developing and maintaining satisfactory relations with other nations, and in competing in an increasingly interdependent global economy."

Too little attention has been given publicly in recent years, Casey said, to the critical role the intelligence community must play "in the formulation and execution of our union's

strike.

"To retaliate, I think we need to have a counterforce capability and over and above that," Carlucci added. "I think we need to have a war-fighting capability. The Soviets are developing a nuclear war-fighting capability and we are going to have to do the same. The prime concern is that the trends are running against us and the window of vulnerability may be upon us very quickly."

In response to questions about his views on strategic arms limitations, Carlucci said he believes the essential point in last year's critical reports on the SALT II treaty by the Armed Services Committee is that the U.S. needs to have "the flexibility to build up our defense establishment."

"So, I would fully support (defense) Secretary-designate (Casper) Weinberger's comment (before the committee last week) that we need to make the basic decisions on defense and then go into SALT and let those (defense decisions) drive the arms negotiations process and not vice versa," he said.

On the subject of chemical weapons, Carlucci said there is "no question but that the Soviets have made big strides and we are going to have to move ahead in that area to match them."



CIVILIANS SEARCHED: Soldiers search civilians at a bus stop in San Salvador Tuesday. A general strike called by the left for the day was not considered to be very successful.

Injured cameraman dies

El Salvador's army repulses guerrilla attack

SAN SALVADOR, Jan. 14 (R) — A self-proclaimed final offensive by leftist guerrillas to topple El Salvador's government before Ronald Reagan becomes U.S. president next Tuesday appeared Wednesday to be weakening.

The army said the guerrillas, who believed Reagan will increase support for the ruling civilian-military junta, had been forced out of all but two major towns.

Fighting was still continuing in Zacatecoluca, 656 kilometers east of San Salvador, and in Gotera, near the Honduran border. Many people reported to have died in Zacatecoluca. Official figures were not available.

An army spokesman said that battles were raging in and around Gotera, also taken by the guerrillas.

Informed sources said a call by the insurgents for a general strike throughout the country, which is under a 10-hour curfew, appeared to have failed.

The strike, due to have started Tuesday, hardly affected San Salvador, the capital, where troops patrolled the streets. Shops, schools and factories were all open. The army denied a report on a clandestine radio, monitored in Nicaragua, saying the guerrillas had taken control of the major eastern port of La Unión. The victims of the fighting included South African television cameraman Ian Mates, who died Tuesday from the injuries received when his car struck a land mine.

The U.S. had resumed economic aid worth \$20 million to El Salvador, but was suspended after the murder of three American nuns and a missionary early December.

Officials put the number of dead at about 1,000 relatively few of them government troops — since the "general offensive" launched last Saturday by the Farabundo Martí National Liberation Front, a grouping of five guerrilla movements. The guerrillas claimed control over three district capitals near the Guatemalan and Honduran frontiers: Chalatenango, Santa Ana and Ahuachapán.

They said they shot down two government helicopters during the fighting while occupying 20 smaller towns and moving into "strategic positions" in 10 out of the central American republic's 14 administrative districts. The guerrillas said 30 "members of paramilitary forces guilty of murders" in the provinces had been summarily shot dead by firing squads.

The Agencia Independiente de Prensa, a news agency with links to the opposition, reported that guerrilla units had been ordered to regroup to build up a second-stage offensive in coming days. The agency said that as the guerrillas moved forward, new administrative, political and military authorities were named to install "local people's power" in each occupied village.

Reports from Washington indicated the U.S. was about to resume its \$5-million milit-

ary aid to the junta.

A broadcast by the rebels' radio station, claiming to operate from somewhere in El Salvador, said they had set up commissions and they will take over administrative duties and build arms factories. They will also be responsible for administering service in the "liberated zones," it added. The guerrillas have also appointed a seven-member political and diplomatic commission representing

Meanwhile, the official Venezuelan News Agency reported that one of two Venezuelan cameramen, who were seized by armed men in El Salvador Monday night, was being held by police there but the whereabouts of his colleague was unknown.

The agency quoted Venezuelan ambassador to El Salvador, Abel Clavijo, as saying that he had spoken with one of the two mis-

INTELLIGENCE BOSS: CIA Director-designate William J. Casey said at his confirmation hearing Tuesday that he intended to reinvigorate, not shake up, the CIA so that it could play a better role

foreign policies and defense strategies." The time has come, he noted, to make American intelligence "work better and become more effective and more competent and make the members of its establishment respected and honored." He promised to reinvigorate the U.S. intelligence community.

Responding to questions from committee members, Casey said any rigid restriction of CIA field agents "has the danger of impairing initiative." He agreed with committee chairman Barry Goldwater (R-Ariz.) that field agents should be able to initiate operations. But he cautioned that covert action "is the kind of thing you do only when it's in the highest interests of the United States."

Meanwhile, Deputy Defense Secretary-designate Frank Carlucci told the Senate Armed Services Committee that U.S. intelligence believes that "Soviet oil production is going to decline." That means, he added, that the Soviet Union "is going to be faced with some very difficult problems."

Carlucci currently is Deputy Director of the Central Intelligence Agency (CIA) and was appearing on Capitol Hill Tuesday for his confirmation hearing on the Defense Department post. "I would not find it at all surprising if, during this decade, the Soviets begin to look for other sources of oil, and we have been from experience how they act when they begin to look for raw materials," he said.

Carlucci said he would expect the Soviets to "step up their subversion in the Gulf area. They already have one client state in South Yemen. They are shipping significant quantities of arms to other states and they are building up Communist parties in a number of these states."

During the course of the 1980's, Carlucci said, he expects these efforts to increase and the U.S. needs to improve significantly "its ability to deal with willful subversion. The Gulf, Carlucci said, is "an area of vital interest to the U.S. and I would support our commitment to do what is necessary to protect our vital interests."

As for the U.S.-Soviet weapons balance, Carlucci said current trends could lead to "an imbalance and the U.S. needs to have the strategic capability to survive a Soviet first-

Belgrade fails to strike enough oil from Adriatic

BELGRADE, Jan. 14 (R) — Yugoslavia, desperate for an alternative to costly imported oil, is pinning its hopes on exploration in the Adriatic Sea.

The country's 1,200-kilometer coastline with the Adriatic has long been a major source of revenue, attracting hundreds of thousands of foreign tourists to seaside resorts from Portoroz in the north to Dubrovnik in the south. Although there have been a number of exploratory drillings in the blue waters of the Adriatic, no oil in commercial quantities has been found. But only about one-tenth of the Adriatic has been explored so far.

"I am confident that the Adriatic will provide satisfactory solutions to our energy problems," said Ivan Sindjica, Secretary-General of the Association of Yugoslav Oil Industries. Yugoslavia's energy problems are daunting. Power needs have almost doubled every decade since the end of World War II to keep pace with the economic development of this country of 22 million people.

But with a chronic balance of payments deficit, the country now finds it increasingly difficult to buy oil on the world market. Yugoslavia's production of crude — currently running at around 4.3 million tonnes a year — has been declining steadily. There are large deposits of brown coal but its quality is

poor and experts predict that it will run out within 50 years.

Under these circumstances, the government has set its sights on offshore drilling for oil and natural gas. The state-owned oil company of Ina-Naftaplin is now using a \$100 million drilling platform for exploration in the northern Adriatic. Sixteen drillings for oil, some over than 6,000 meters, failed to tap commercial deposits. But the company struck natural gas 1,500 meters under the seabed last year.

Some 60 km. south of the tip of the Istrian peninsula, the gas field is expected to provide up to three billion cubic meters of gas annually when commercial exploitation starts in 1985. Ina-Naftaplin, based in the western city of Zagreb, also spent \$170 million — including foreign credits — recently to open an inland gas field at Molve near the Austrian border.

But the company's emphasis is on Adriatic drilling. The management has said it will shortly put up two more offshore platforms to speed up prospecting in the northern and central Adriatic. Ina-Naftaplin has been in touch with a number of west European and north American companies and announced recently it would invite international bids with offers to be submitted by mid-March.

Defector reveals valuable secrets

BONN, Jan. 14 (R) — A Soviet interpreter, who defected to West Germany last month, has revealed valuable information on Soviet conduct of the talks in Vienna on troop reduction, informed sources have said here.

Viktor Korolyuk, 35, who worked at the Vienna conference until mid-December, gave information about the Warsaw Pact negotiators and the influence of the military on the Soviet bloc line.

He also threw light on the response to past western initiatives at the 19-nation conference which resumes next week after a Christmas recess. The talks, involving NATO and Warsaw Pact nations, started seven years ago and are stalled by a dispute over the size of the pact's forces in central Europe.

After news of Korolyuk's defection broke last week there were conflicting assessments of his likely value to the West, with sources in Vienna discounting press reports that he had access to the Warsaw Pact secrets.

It was now clear, the sources said, that Korolyuk was not in the same league as Werner Stiller, the East German state security officer who fled to the West in 1979 with information which led to the arrest of more than 20 suspected spies. "He's not that big but he is of medium importance," one informant said.

Korolyuk, who has relatives in West Germany, spent two days hiding in Vienna before taking a plane to Duesseldorf a week before Christmas. Soviet officials notified his absence only on the second day, the sources said.

Contrary to some reports, Korolyuk did not bring secret documents with him, they said.

Panda farm gets ready

HONG KONG, Jan. 14 (AFP) — Communist conservationists have completed work on a small farm to breed giant pandas in the Wolong nature reserve in the Sichuan province, the New China News Agency has reported.

The farm, surrounded by a high fence, has six pandas and contains many groves of arrow bamboo, the panda's food.

Wolong, with an area of about 200,000 hectares, is the largest of ten panda reserves in Communist China. It spends \$3,246 every year on the conservation of pandas.

Fuel cost, technical issues

Concorde suffers another setback

PARIS, Jan. 14 (AP) — The graceful but financially hobbled supersonic jetliner Concorde, which flies across oceans and continents at twice the speed of sound, has suffered another setback in its brief career.

The government-run airline, the world's number three carrier in terms of mileage and passengers, said it plans to concentrate its direct flight service only to New York during 1981.

Poor planning and bad luck have consistently plagued the Concorde since it first took to the sky five years ago this month.

The French-British project was begun in 1961. French President Charles de Gaulle confidently predicted at the time that the streamlined Concorde would end "American colonization of the skies."

But rising fuel costs, demonstrations over the Concorde's noise and a failure to keep up with technical innovations have effectively killed that expectation.

Britain and France spent the equivalent of \$3.2 billion to develop the Concorde. Only 16 planes have been built, far less than the 150 planes needed to recover the developmental costs.

In headier days, France and Britain talked of selling 300 planes. But there has not been a serious Concorde customer in five years. Only Air France and the state-operated British Airways fly the controversial supersonic jet.

In September 1979, the two European countries decided to close their twin Concorde assembly lines, spelling the end of the jet's production.

In its yearly financial report for 1980, Air France said it lost \$10 million on its Concorde routes despite a \$52 million overall profit. Because of the high losses, the French government announced Jan. 6 that it would boost the share of the Concorde's losses that it would cover from 70 to 90 per cent.

British Airways reported it lost the equivalent of \$35 million on its five Concorde in 1978 alone.

The Concorde can travel at speeds close to 2,253 km per hour and span the Atlantic in three-and-a-half hours, twice as fast as a Boeing 747 jumbo jet.

The price of a Concorde ticket, however, is about twice as much as a non-supersonic carrier. A one-way ticket between New York and Paris sells for \$1,400.

The Concorde has room for only 100 passengers, less than one-third of the seating capacity of a Boeing 747. It uses more than four times as much fuel as the bigger American jumbo jet.

Bonn ready to go to court over EEC budget increase

BONN, Jan. 14 (AFP) — West Germany is ready to go to court over the 1980 budget increase approved by the European parliament in December and endorsed Tuesday by EEC Commission President Gaston Thorn, a reliable source said.

The source said that, if necessary, Bonn would take the matter to the European court in Luxembourg — a move that France, another opponent of the increase, so far has not been disposed to take.

West Germany will probably confirm its opposition to the supplementary budget next week, the source said. West Germany, France and Belgium have refused to pay their

Aerospace experts see no possibility of increasing the Concorde's seating capacity. To do so, they say, would mean that the Concorde would not be able to cover the 5,633 km across the Atlantic without a fuel stop.

Air France says its Paris-New York Concorde flight is especially popular with businessmen and averaged 71 per cent full on that route last year. But the ticket sales are not nearly enough to cover the Concorde's engine and fuel costs, which account for 33 per cent of its total running costs.

When the Concorde was being built, it was projected that fuel costs would amount to about 10 per cent of the budget. Airline fuel prices, however, jumped 121 per cent just between 1979 and 1980.

The Concorde travels at a noise level four times louder than a Boeing 747. Environmentalists kept the jet from landing in New York for two years, while Tokyo still refuses to let it land.

Iran hikes oil price

LONDON, Jan. 14 (AFP) — Iran has raised its oil rate from \$35.37 to 37 a barrel backdated to Jan. 1, oil industry executives said Wednesday.

They noted that the \$1.63 increase was modest as compared with the \$3 or 4 rise by other members of the Organization of Petroleum Exporting Countries (OPEC). It was less than Saudi Arabia's \$2 rise.

The sources said oil was reported reaching Iran's Kharg terminal in large quantities. The Iranians were reported negotiating new deals with traditional customers in Japan, Spain, India and eastern Europe. Some Iranian oil was reaching the spot market.

EEC leader dies of heart attack

STRASBOURG, Jan. 14 (AFP) — Finn Olav Gundelach, who died here Tuesday after a heart attack, had just started a second four-year term as commissioner for the European Economic Community's common agricultural policy.

He died at 9 a.m. (0800 GMT) shortly before he was to explain the sale of EEC butter to the Soviet Union to a commission of the European parliament, which sits here.

Gundelach was Denmark's ambassador leading negotiations for his country's membership of the ten-six member Community and joined the Commission in 1972.

When Denmark joined the market with Britain and Ireland on Jan. 1, 1973, he became his country's first commissioner, with the task of handling the Community's troubled agricultural dossier. Agriculture is the EEC's only genuine common policy.

Gundelach, 56, entered the foreign ministry in Copenhagen in 1951, in charge of relations with the North Atlantic Treaty Organization and the Organization for Economic Cooperation and Development. Between 1955 and 1959 he represented his country at the United Nations in Geneva.

Between 1959 and 1961 he was director at the general agreement on tariffs and trade (GATT) in Geneva. He became deputy director general and handled negotiations for reducing tariffs in the so-called Kennedy round between 1962 to 1967. Gundelach is survived by a wife and two children.

BRIEFS

MOULINEX Conference the 12th annual Moulinex Pan-Arab Conference was held at the Holiday Inn, Bahrain, from Nov. 28 to Dec. 1. This has been an annual event organized by Moulinex Electro Menager of Bagnolet, France, and attended by Moulinex agents from all of the Gulf countries, Saudi Arabia, Syria, Jordan and Lebanon, along with the Middle East distributor, S. Gorayeb & Co. Agreements and background of increasing sales of Moulinex appliances in all of the markets, traditional purpose of this conference has been to review and discuss the company's performance with its agents, and to discuss marketing, sales and promotional activities for the coming year. The conference was attended by Heide la Loge, M. Nemine and Pabondjian from Moulinex; Sammy Gorayeb of S. Gorayeb & Co; E. Guercovich, Edmond Moutran, S. Vaswani, A. Khleif, T. Fernandes and N. Sfeir of Internation Advertising Agency; also the Moulinex agents, S. Badreig, Saudi Arabia; O. Reza, Qatar; B. Bahman, UAE; C. Shah, Oman; A. Ashkanani, Kuwait; S. Zannari, Jordan; K. Al Murrassi, North Yemen; Essa Mahmood, Farouq Mahmood and Mahmood Hussein, Bahrain; A. Srour, Beirut.

TOKYO, (AP) — Yamaha Motor Co., a leading motorcycle and agricultural machinery maker, announced a plan Tuesday on joint production of two-wheel vehicles in subsidiaries in Mexico, Spain and Nigeria. Production is to start by the end of this year.

WASHINGTON, (AP) — India will borrow \$23 million from the U.S. Export-Import Bank and an equal amount from private sources for U.S. equipment and know-how to develop its oil resources, the bank announced Tuesday.

LONDON, (AFP) — Interest on deposit accounts is to be paid in one-ounce or half-ounce Kruggerands or British sovereigns, if the customer wishes, by the standard chartered bank, which has close links with South Africa. The deposit must be at least £1,000 and be for at least one year, for the customer to be granted this facility. Interest is based on the sterling inter-bank rate.

THE HAGUE, Netherlands, (AP) — Ships chartered to Dutch oil companies or sailing from Dutch refineries apparently have provided more oil to South Africa than vessels from any other nation, an anti-apartheid group said Tuesday.

PARIS, (AFP) — Japanese cars totalled less than 2.9 per cent of the French new car market during 1980 — a figure falling just below the three per cent (56,000-vehicle) import limit decreed by the French government since 1978, a reliable source said.

Foreign Exchange Rates

Table with columns for Currency, Rate, and Date. Includes entries for Bahraini Dinar, Belgian Franc, Canadian Dollar, Deutsche Mark, Egyptian Pound, French Franc, Greek Drachma, Indian Rupee, Israeli Riyal, Iraqi Dinar, Italian Lira, Japanese Yen, Jordanian Dinar, Kuwaiti Dinar, Lebanese Lira, Moroccan Dirham, Pakistani Rupee, Philippine Peso, Pound Sterling, Qatari Riyal, Singapore Dollar, Swiss Franc, Syrian Lira, Turkish Lira, U.S. Dollar, Yemeni Riyal, Gold, 10 Tons bar, Silver.

PORTS AUTHORITY JEDDAH ISLAMIC PORT SHIPS MOVEMENTS UPTO 0700 HOURS ON THE 14TH. JANUARY '81 — 08TH. - R. AWAL. 1401. Table with columns for Berth, Name of Vessel, Agent, Cargo, Date. Includes sections for VESSELS DISCHARGING and RECENT ARRIVALS.

DAMMAM PORT MANAGEMENT Ship movements up to 0700 hours SHIP MOVEMENTS UP TO 0700 HOURS ON 8.3.1401-14.1.81 — CHANGES. Table with columns for Berth, Ship, Agent, Cargo, Date. Includes section for VESSELS DISCHARGING PAST 24 HOURS.

PARKER PLANT MOBILE AND FIXED ASPHALT PLANTS WITH CAPACITIES UP TO 350 PER HOUR. Includes an image of the asphalt plant and contact information for Parker Plant EXPRESS CONTRACTING & TRADING.

Saudi Arabian Government Tenders. Table with columns for Authority, Description, No. of Tender, Price SR, and Date. Includes entries from Ministry of Municipal and Rural Affairs, Directorate of the National Guard, University of Petroleum and Minerals, Department of Education, Municipality of Abha, and Directorate General of Municipal and Rural Affairs.

ANDALUS PLAYA AN ARABIAN HOMES DEVELOPMENT. BEACH RESORT DEVELOPMENT ON SOUTH CREEK, FEATURING AIR-CONDITIONED SPANISH-STYLE CABANAS, WITH LOUNGE, BEDROOM, SHOWER ROOM, FITTED KITCHEN & PATIO. SWIMMING POOL (25 X 12.5M) TENNIS COURT COFFEE SHOP, CHILDRENS POOL, JETTY, BOAT PARK, BEACH, LANDSCAPED GARDENS, SKI-BOAT AND SAIL BOAT HIRE. FULL MAINTENANCE AND SECURITY PROGRAMME. FOR FURTHER INFORMATION RING TONY WALTERS ON 6828381 - 6824210 EXT: 561.

U.S. board rejects Chrysler's plan

WASHINGTON, Jan. 14 (R) — The Chrysler Corporation has failed to present a long-range financial plan acceptable to the U.S. Treasury Secretary William Miller and the board of the government's Chrysler Guaranty Board, said: "The board does not feel the plan presented by Chrysler is adequate. It needs to be fine-tuned."

Chrysler executives have said the firm might run out of cash by the end of the month if it did not have new loan guarantees by then.

Press reports say some banks have reached the conclusion that they can hope to collect only 20 cents on every dollar they have lent to the carmaker. The Washington Post said Tuesday that these banks want to conclude their ties with Chrysler as soon as possible.

American auto manufacturers finish bad year on sour note

LOS ANGELES, Jan. 14 (LA) — American auto makers finished a bad year on a sour note with December car sales falling 18 per cent below year-ago levels, the industry said.

Among the domestic auto companies, only Chrysler Corp. had a sales increase for the month, turning in its best sales performance in nearly three years. The sharp upturn in December sales gave Chrysler executives the impression that they have had in months past, a time when the auto maker is trying to convince the public and federal officials that Chrysler can survive.

Chrysler's sales were up slightly from the same period of 1979, just as they have been for the last three months. However, the company's sales success is somewhat misleading because in late 1979, Congress was debating a federal loan guarantee package for the company. The resulting publicity of that debate sent Chrysler sales down sharply.

However, the company's sales in December, normally one of the slowest months of the year at car dealerships, were also up from November. And Chrysler said that in the final 10 days of the month, sales of its K-cars were, on a daily rate basis, the highest for any 10-day sales period. The automaker captured 13.3 per cent of the domestic market in December, the best it has done since April 1978.

The company has been paying sales rebates pegged to the prime lending rate, and the present price discount of seven per cent is credited by analysts as being a major reason for Chrysler's recent sales success.

"It only demonstrates the axiom that if you reduce the price enough, you will bring in the sales," Arvid Jouppi, an industry analyst with the Wall Street firm of John Muir and Co., said.

The industry's 1980 sales were affected by the most serious market obstacles we have seen in more than a quarter of a century," said A. Staudt, vice-president of market research at American Motors Corp., said as he stepped off the familiar list: High interest rates, recession, sagging consumer confidence, increased competition from overseas.

Analysts had expected the year to end on a sour note, since the industry had begun to slip out of the slump through the late summer and early fall. But the renewed high interest rates of November and December snuffed the slow recovery, and the December rate fell to its lowest level since June.

Australian research to study amount of energy in oil barrel

By Kathy Land

RISBANE, Jan. 14 — How much energy can be extracted from a barrel of oil when it is used as fuel for an internal combustion engine? In Australia, a research team led by D.J. Nicklin, head of the University of Queensland's department of chemical engineering, aims to find out.

The team has recently begun work on a three-year study project, funded by the Australian National Energy Research Development and Demonstration Council. The beneficiaries of the study will be manufacturers who could use the findings to design more cost-efficient motor vehicles. When oil cost \$1.80 a barrel no one would know too much how it was divided up in terms of effective energy," said Nicklin. "It is almost 20 times dearer there is an urgent need to make sure that the world's oil reserves are treated in such a way that the optimum amount of energy is obtained."

Nicklin said finding the answer would involve complex calculations carried out on the basis of known data. He said that the energy content of crude oil varied according to its origin, but within those limitations

each barrel could be divided according to different refinery techniques into various products including high and low octane petrol, diesel fuel, kerosene and gases.

Despite enormous inertia in the manufacturing system, there were signs that market pressures were being exerted in the direction of more economical transport. He said it was therefore important to assess the contribution that different types of fuel could make toward that goal. It was necessary to know whether, in making the most effective use of the world's petroleum resources, it would be best to concentrate, for example, on diesel or LPG engines. Also, the question could be asked whether petrol could be shown to justify its place as the most popular of the liquid fuels and, if so, what were the best octane levels for premium and regular gasoline.

Nicklin said this research would complement experiments being carried out in the university's department, of mechanical engineering to establish how to make the best use of the horsepower available. The combination of efficient processing plus a correct choice of engine would produce maximum horsepower on the road.

Disagreements over agenda halt N-S talks

UNITED NATIONS, Jan. 14 (R) — Plans have been abandoned for a new round of talks between the developing and industrialized countries on world economic problems before the 36th United Nations General Assembly begins in September, a U.N. spokesman said.

The talks, a resumption of the so-called North-South dialogue, were due to start Monday, but were prevented by disagreements over agenda and procedures.

The developing countries want the assembly to be the supreme authority in the proposed negotiations, while Western industrialized states want to use bodies such as the World Bank, the International Monetary Fund and the General Agreement on Tariffs and Trade (GATT), in which they have a dominant role.

Attempts by assembly President Ruediger Von Weizsacker to break the deadlock Monday were unsuccessful, but the assembly is expected to ask him to continue his efforts when it resumes its session Thursday.

Thai government takes steps to conserve oil consumption

By Edward Thangarajah Arab News Correspondent

BANGKOK, Jan. 14 — Private car owners in Bangkok will have to curtail their weekend pleasure and business trips. This is one of many oil conserving measures the Thai government will introduce shortly to counter the increase in prices. The travel ban is to be imposed end of this month.

There are some 250,000 private cars and on an average each car will be permitted to run about eight to ten hours on Saturdays and Sundays. Late last month the Thai government decided to introduce a speed limit of 90 kilometers per hour for private cars.

Another measure the authorities plan to implement is a car-curfew from 1 a.m. to 4 a.m. This may come into effect if consumption does not reduce by at least ten per cent after the price increase.

Meanwhile, Thailand's Deputy Commerce

Curb on weekend trips

Minister Tansacha, who returned from a trip to the Middle East after discussions on Thailand's energy, economic and political situation with leaders of oil producing countries, told Arab News Wednesday that Kuwait was prepared to supply Bangkok with 30,000 barrels of crude oil and any amount of refined petroleum products. He said the price was rather high but negotiable.

Tansacha, who described his trip as successful, also said that Kuwait was ready to sign a long-term oil supply contract and wanted more information on Thailand's requirements of refined petroleum products.

In Saudi Arabia, he said the authorities sympathized with Thailand's oil situation and promised to do everything possible to improve it. Of his trip to Abu Dhabi, the deputy minister revealed that suggestions were made to exchange trade commissioners to help increase trade and economic relations between the two countries.

Oil sales increase by 41 per cent

NEW YORK, Jan. 14 (AP) — "For the oil companies 1979 was some year," Fortune Magazine reported while publishing its yearly list of the 500 largest industrial companies of the non-Communist world outside the U.S.

The fortnightly U.S. business magazine puts the oil sales increase at 41.2 per cent. "At the very top Royal Dutch Shell entered the 24th year of its reign as no. British Petroleum was next for the second year in a row. Further down the list, oil companies displayed impressive upward mobility. Italy's government-owned Eni leaped from No. 10 to No. 4 and Francaise des Petroles from No. 11 to No. 6.

The largest leap was that of British National Oil. North Sea oil boosted the company to No. 43, with an eight-fold increase in sales and a profit for the first time since its creation in 1976.

Other oil-company vaulters include Kuwait National Petroleum (from No. 174 to No. 93) Britain's Ultramar (from No. 285 to No. 193), and Essonnederland (from No. 283 to No. 191).

See Us At The 1st RIYADH Motor Show!



DATE / Jan 21-30 PLACE / AL-DHIAFA EXPO. CENTER RIYADH
4:00PM - 9:00PM

Come to see the wide array of current Datsun models at the coming Riyadh Motor Show! The Nissan booth will also be featuring various exhibits, including a driving simulator, on a driving safety theme. Special handbooks will be distributed along with other gifts and refreshments. Come and see the Datsuns and enjoy yourself!

DATSUN CREATES SAFETY

Datsun's dual perspective for safer driving: Accident Prevention and Passenger Protection.

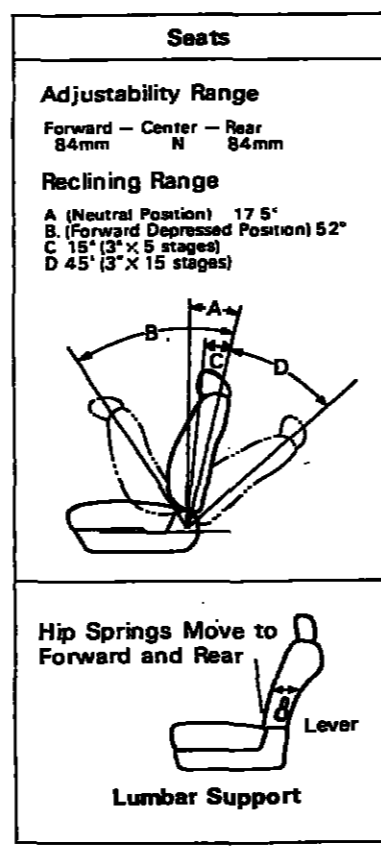

Datsun seating is designed to be both functional and exceptionally comfortable.

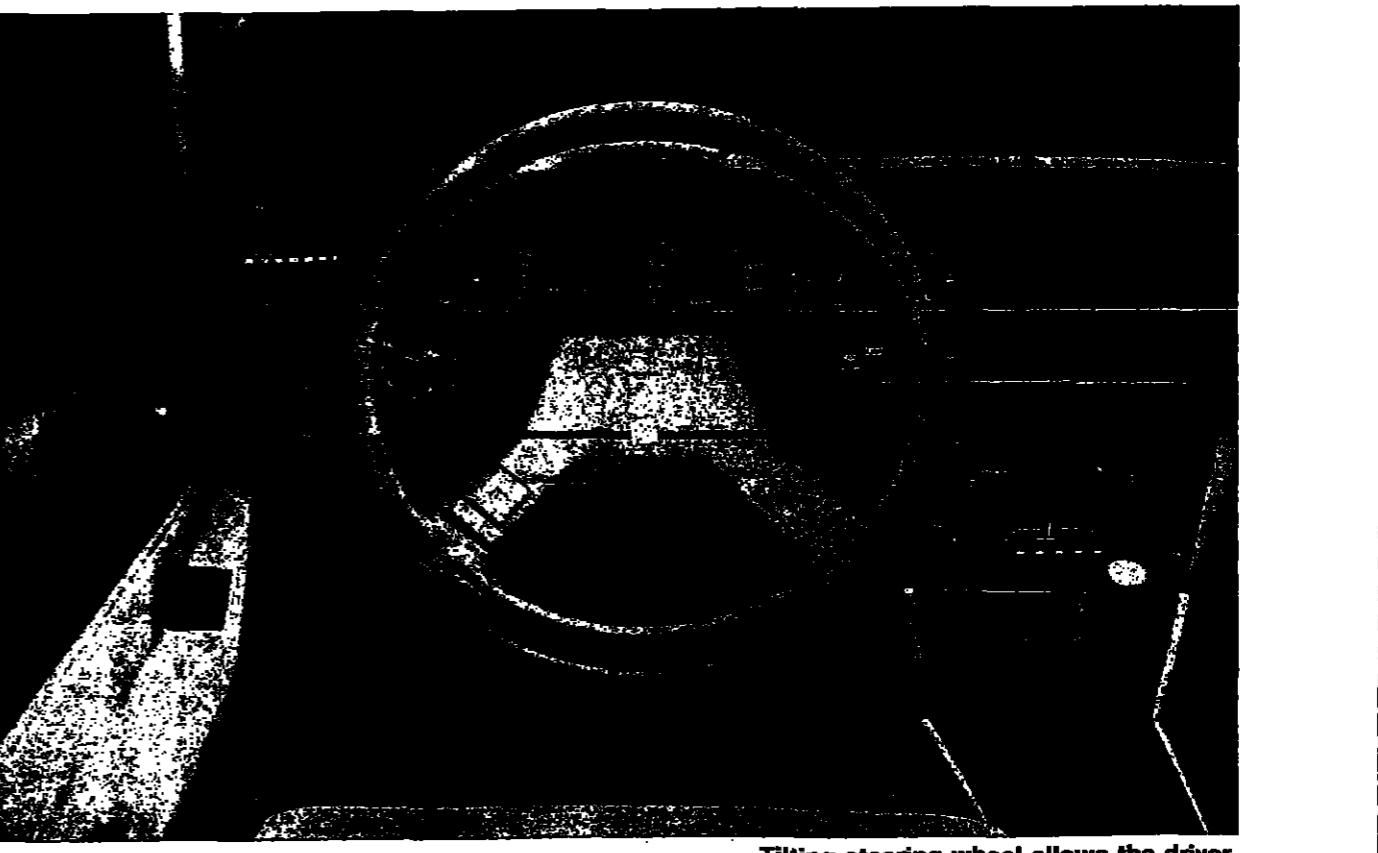

Tilting steering wheel allows the driver to choose the position that suits best.

One of the driver's biggest enemies is something he may not even be aware of: his own fatigue. Driver fatigue causes errors that can lead to injury and even death. That's why the cockpit of every Datsun car is designed for optimum ease of operation and relaxing comfort.

Positioning of instruments and controls is based on thorough human engineering studies to ensure that everything is within natural reach of the driver. Stalk-mounted switches on the steering column

provide fingertip control, while meters and warning lights are clustered for maximum visibility.

To allow optimum positioning, steering wheel height can be freely adjusted. Also, the driver's seat features both sliding and reclining functions. And, to ease back ache, variable lumbar support is a welcome feature for those long journeys.

Helping to prevent driver fatigue is just one of the ways Datsun is working to make driving safer. Drive safe, drive Datsun!

Instalment facilities and considerable cash discounts

SIRAJ H. ZAHARAN & CO. Head Office: Jeddah, Medina Road P.O. Box 701, Jeddah Tel. 6650745 Abha: South Centre, Tel. 7701 DAMMAM - AL JABRE TRADING CO. TEL: 24285 BURAIDAH - AL MUSHAIKH TRADING CO. TEL: 4784

AL HARAMI TRADING & IMPORTING CO. RIYADH - TEL: 4767515

CUT OUT AND BRING TO THE NISSAN DATSUN BOOTH GIFT COUPON NISSAN DATSUN

NOTICE

TO FAMILY COMPOUNDS IN THE EASTERN PROVINCE

Interested in distributing Arab News in your compound !! Please contact Keith at our Al-Khobar Office — Tel : 8642991

Jabbar strikes late

Los Angeles Lakers rally to beat Cavaliers

NEW YORK, Jan. 14 (AP) — Center Kareem Abdul-Jabbar scored four clutch baskets in the fourth quarter as the Los Angeles Lakers rallied to beat the Cleveland Cavaliers 108-104 in the National Basketball Association Tuesday night.

The Lakers trailed 69-58 midway through the third quarter before guard Norm Nixon got them untracked, scoring 15 points in a 4½-minute span as Los Angeles pulled in front by as many as 10 points. Then Abdul-Jabbar took over, hitting four shots in the last four minutes to turn back a Cleveland comeback.

Abdul-Jabbar led the Lakers with 29 points and Nixon scored 25. Nixon, who sprained his right ankle Sunday in Detroit, didn't test it until the pregame warmup. Nixon's play helped the Lakers to their fourth consecutive victory. Los Angeles' record is now 30-16, including 15-11 since guard magic Johnson suffered his knee injury.

Dallas Mavericks 112, Chicago Bulls 106. Reserve forward Abdul Jeelani scored eight points in the first 3:20 of the fourth quarter to help the expansion Mavericks to only their seventh victory of the season.

Bill Robinzine scored a season-high 26 points and Tom Lagarde 24 for Dallas, but Jeelani's 16 in the fourth quarter made the difference. The Mavs led by just two points going into the final period, but Jeelani's scoring kept them on top.

Phoenix Suns 104, Seattle SuperSonics 99. Guard Walter Davis hit two jump shots in the final minute as Phoenix held off Seattle. The Sonics had wiped out a nine-point deficit to draw even with 2:35 to play but were out-

scored 7-2 after that. Len Jobinson scored 22 points for Phoenix and ex-Sonic Dennis Johnson added 18. Paul Westphal, who was dealt to Seattle last summer in exchange for Johnson, led the Sonics with 19 points.

Boston Celtics 93, New York Knicks 89. Boston held New York without a field goal for the final 4:17 and outscored the Knicks 8-3 down the stretch to post its fifth consecutive victory. Larry Bird topped the Celtics with 21 points and also had 11 rebounds and eight assists.

Milwaukee Bucks 119, Detroit Pistons 96. Milwaukee outscored Detroit in the third period to wipe out an eight-point halftime deficit and hand the Pistons their fifth straight loss. Marques Johnson led Milwaukee with 34 points, in the third period when the Bucks reeled off 14 in a row.

Denver Nuggets 135, Atlanta Hawks 132. Two free-throws apiece by David Thompson and Kiki Vandeweghe in the last 25 seconds gave Denver the victory over Atlanta. Alex English topped the Nuggets with 36 points while John Drew scored 33 for Atlanta.

Brian Sipe -- the unknown hero

By Bob Oates
The Los Angeles Times

When Cleveland Browns quarterback Brian Sipe was growing up in California, his favorite sport wasn't football but surfing.

Eventually they got him out from football in high school because he was bigger than most kids. Although at 6-1, and 195 he is a rather small pro quarterback, he was a fast grower, a high school heavyweight, but given his choice in those days, he'd really rather surf.

Arising at 4:30 a.m. at his home in La Mesa, a San Diego suburb, he would head for the beach like any other California kid and hit the boards before class. At 31, he still gets out in the ocean in the offseason when he comes home to California to live for a few months, but he's beginning to wonder if it's worth it. "When he shows up with his surfboard," his wife Jeri said, "The kids say: 'Here comes old man Sipe.'"

As the leader of the Browns, Sipe commands more respect in the National Football League. This year, indeed, even before he won the league's passing championship, some critics were calling him the best quarterback in the game — though he remains the quar-

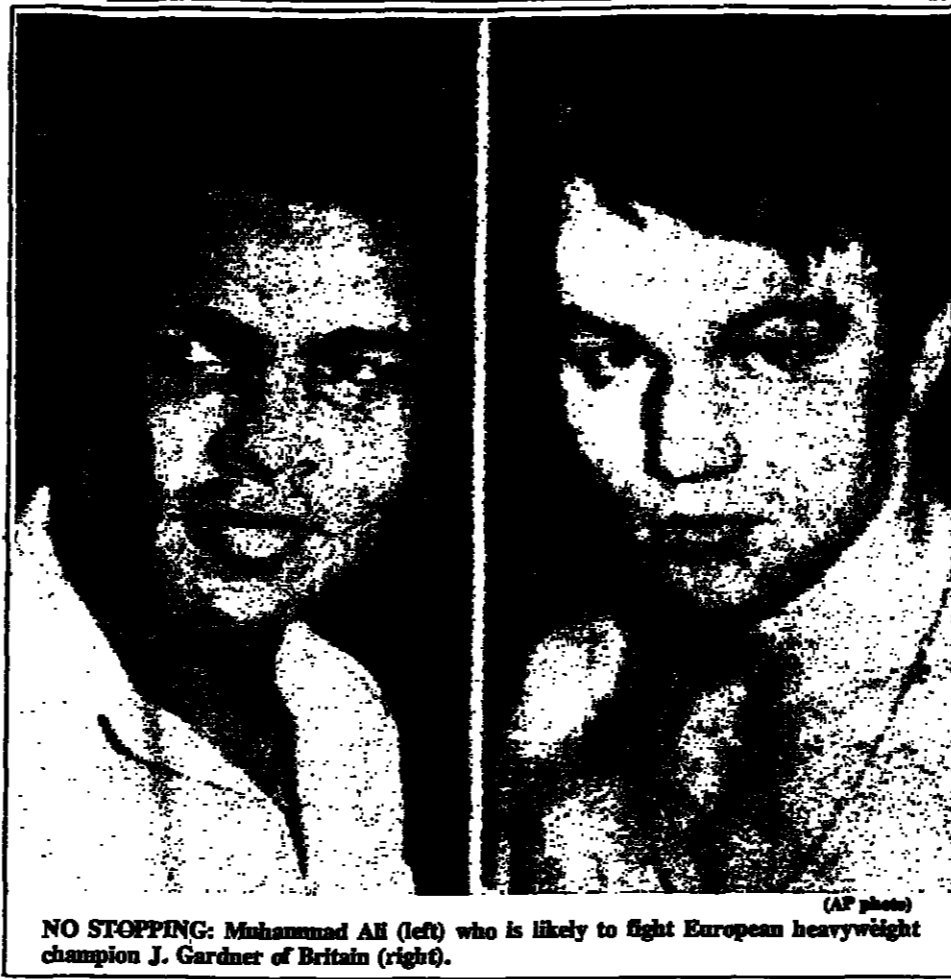

NO STOPPING: Muhammad Ali (left) who is likely to fight European heavyweight champion J. Gardner of Britain (right).

terback nobody knows, the least publicized, perhaps, of the nation's top athletes.

Partly as a result of all those years strengthening his arms on surfboards, Sipe finished first on the NFL's 1980 passing ladder with 91.9 rating points. He completed 61 of 340 passes for 4,132 yards and threw only 14 interceptions with 30 touchdowns.

So doing, he led the Cleveland team to an 11-5 record and the championship of the AFC Central ahead of Pittsburgh and Houston. "Brian probably is the most valuable player in the league because he took a fairly good team, with very average coaching, to the divisional championship," said coach, Sam Rutigliano.

The Browns, in fact, had drafted him on the 13th round (out of San Diego state) — and show you how far down that is, the league doesn't even have a 13th round any more, ceasing after 12. Sipe was the 330th NFL player drafted in 1972 and the 12th quarterback. Of the first 111 none became an NFL household word. But all had better pre-draft credentials than Sipe, who was summed up as follows in one scouting report (and probably others): "No size, no mobility, no arm."

So what has Sipe got? has he improved

since his days on the taxi squad — or did the Browns simply realize, finally, that they had a winner?

"We gave Brian the opportunity," Rutigliano said. "But more important, he rose to the occasion. He had everything to do with his development, and deserves most of the credit."

Sipe launched his sports career in 1961 as an 11-year-old catcher on California's El Cajon-La Mesa team that won the Little League World Series at Williamsport. "I was the only 11-year-old on the team," he said. At San Diego state in the early 1970s, he was the nation's champion college football passer although that didn't mean very much on Don Coryell team. Any Coryell quarterback was likely to win that title.

Moreover, Sipe's passes had (and have) a tendency to wobble. And as anyone can see, they still don't travel very fast. How does he get by? The answer, briefly, is that Sipe is the master of the intangibles. Rutigliano agrees that Sipe's domain is the initiative or intangible aspect of passing.

Sipe's improvement from 1979 to 1980 must have had some of its roots in the support he gets from such as Rutigliano. Asked about it, he said: "Sam is the best thing that ever

In World Cup Cricket

Kiwis register one-run win over Australians

SYDNEY, Jan. 14 (AP) — New Zealand won a cliff-hanging thriller by one run in the Benson and Hedges World Cup cricket clash at the Sydney cricket ground Tuesday night. With one over remaining, eight runs were needed for an Australian victory. New Zealand had made 220 in 50 overs for the loss of eight wickets.

Australia with a whirlwind partnership of 78 from Doug Walters (50 N.O.) and Rodney Marsh (49), had pulled back from almost certain defeat at 123 for five to 201 for six when Marsh left. Walters and Shaun Graf were together in the last over bowled by Martin Snedden needing eight to win.

Australia needed three runs from the last ball of the game with Walters facing Snedden. Walters drove the ball past the bowler and the batsmen rushed for one but Graf was run out trying for a second run.

Unlike the usual run of one-sided games at the SCG, not one of the 20,855 left the ground until the last ball had been bowled. Man of the Match John Wright, who top-scored for New Zealand with 78, had the Kiwis into a sound position to force the win which was vital to New Zealand's appearance in the series finals.

Wright and tail-ender Ian Smith had bat-

tered the Australian bowling in the late stages of the New Zealand innings. Wright was later taken to hospital for an X-ray of the index finger of his left hand after he had received several blows from the Australian pacemen.

The finger was swollen and bruised but no break was apparent, however, Wright did not take the field during the Australian innings. Pascoe was the leading Australian wicket-taker with backed up by Shaun Graf. Dennis Lillee bowled an economical 10 overs including two maidens for only 27 runs without taking a wicket.

Score-board
NEW ZEALAND:
B. Edgar b Hogg 0
G. Howard b Pascoe 20
J. Parker c Pascoe b T. Chappell 23
M. Burgess c Walters b Graf 14
J. Wright c Marsh b Pascoe 18
I. Smith c T. Chappell b G. Chappell 78
R. Hadlee c Hogg b Graf 9
T. Cairns b Pascoe 7
I. Smith not out 23
M. Snedden not out 8
Extras 20
Total (for 8 wickets) 220
FALL OF WICKETS: 1-2, 2-30, 3-75, 4-105, 5-124, 6-176, 7-181, 8-191.
BOWLING: Lillee 10-2-27-0; Pascoe 10-0-37-3; Graf 10-0-40-2; T. Chappell 5-0-21-1; G. Chappell 9-2-35-1.
AUSTRALIA:
A. Border b Chatfield 8
G. Wood c Smith b Cairns 37
G. Chappell c Cairns b Cairns 30
K. Hughes c Smith b Snedden 21
T. Chappell run out 0
R. Marsh c Smith b Hadlee 49
D. Walters not out 50
S. Graf run out 7
Extras 17
Total (for 7 wickets) 219
FALL OF WICKETS: 1-18, 2-74, 3-90, 4-122, 5-125, 6-201, 7-219.
BOWLING: Chatfield 10-2-26-1; Cairns 10-0-41-0; Cairns 10-1-48-1; Snedden 10-0-41-1; Hadlee 10-1-48-1.

Rugby training starts

Local rugby players will be turning out at the Jeddah Arms Park on Thursday at 4.00 p.m. as training starts again after the holiday break. Interested newcomers should contact Tony Wood on 6829454.

Kirmanji advised rest

SYDNEY, Jan. 14 (AFP) — India's Test wicket-keeper, Syed Kirmanji, has been advised to rest from cricket for the next five nights. The 31-year-old Kirmanji has had strained hamstring muscles during the last three weeks, and the fear is that he will injure himself seriously if he continues playing. India have two limited-over international which they must win in the next four days to qualify for the final of the rich Benson and Hedges World Series Cup.

India play Australia under floodlights Thursday and then fly to Brisbane for a day match against New Zealand on Sunday.

PENTAX ME SL

SHAMSUDDIN ASHRAF
P.O. BOX 285 AL-KHOBAR TEL. 861100

Notice of Sale

THE FOLLOWING ITEMS OF USED APARTMENT FURNITURE LOCATED IN AL-KHOBAR ARE OFFERED FOR SALE TO HIGHEST BIDDER. ALL IN FAIR CONDITION:

- 12 EACH BEDFRAME DOUBLE WOOD
- 33 EACH BEDFRAME SINGLE STEEL
- 27 EACH BEDFRAME SINGLE WOOD
- 51 EACH CHAIR DINING STRAIGHT
- 8 EACH CHAIR FOLDING PADDED SEAT CROME FRAME
- 55 EACH CHAIR KITCHEN STRAIGHT
- 34 EACH CHAIR LOUNGE CROME FRAME W/CUSHION
- 2 EACH CHEST OF DRAWERS W/MIRRORS 5—DRAWERS
- 11 EACH CHEST OF DRAWERS WITHOUT MIRROR 5—DRAWERS
- 13 EACH CHEST OF DRAWERS 6—DRAWERS
- 16 EACH COFFEE TABLE CROME FRAME GLASS TOP
- 12 EACH CONDENZA 5—DRAWER 3—DOORS
- 12 EACH DESK WOOD QUARTERS STYLE
- 15 EACH DOUBLE BUNK STEEL
- 34 EACH END TABLE CROME FRAME GLASS TOP
- 10 EACH END TABLES WOOD
- 6 EACH MATTRESS COTTON, KING SIZE
- 12 EACH MATTRESS COTTON, DOUBLE SIZE
- 110 EACH MATTRESS COTTON, SINGLE SIZE
- 23 EACH MIRRORS
- 59 EACH NIGHT STAND WOOD, 1—DRAWER
- 67 EACH NIGHT STAND WOOD, 2—DRAWER
- 4 EACH NIGHT STAND WOOD, 3—DRAWER
- 14 EACH OVERSTUFF CHAIR
- 3 EACH OVERSTUFF COUCH
- 20 EACH ROOM DIVIDER GLASS SHELF
- 5 EACH STACKING CHAIRS PADDED SEAT
- 33 EACH SOFA CUSHION CROME FRAME, 3—CUSHION.
- 12 EACH STANDING LAMP WITH SHADE
- 123 EACH STANDING CIGARETTE STAND
- 25 EACH TABLE DINING WOOD TOP CROME BASE
- 34 EACH TABLE LAMP BASE ONLY
- 34 EACH TABLE LAMP SHADE ONLY
- 18 EACH TABLE LAMP GOOSE NECK METAL
- 23 EACH TABLE LAMP WITH GLASS SHADE
- 101 EACH WARDROBE CLOSET WOOD, 2—DOORS
- 2 EACH WARDROBE CLOSET WOOD, 5—DOORS
- 12 EACH WARDROBE CLOSET WOOD, 4—DOORS

FURNITURE CAN BE INSPECTED JANUARY 17 AND 18, 1981 AT THE BIN JUMA'A BUILDING AND MKSAC WAREHOUSE IN AL-KHOBAR.

CONTACT: MANAGER OF PROCUREMENT 86-41979
PROPERTY ADMINISTRATOR 86-45052

SEALED BIDS ONLY WILL BE ACCEPTED. BIDS WILL BE OPENED AT 10:00 A.M. AT THE MKSAC OFFICE IN THE PEASE HAWK BUILDING IN AL-KHOBAR, IN THE OFFICE OF THE PROCUREMENT MANAGER 21 JANUARY 1981.

HAJI HUSEIN ALIREZA & CO

P.O. Box 40, Bab Mecca
(opp. Asia Hotel) — Jeddah
Phone: 6423509/6423802
Telex: 401221 HUSREZ SJ

Lister
 DIESELS SPARES & SERVICE

HAWKER SIDDELEY
 POWER PLANT
 GENERATING SETS

Visit the
Haji Husein Alireza stands
Section A, No's 145/1 & 145/2
at the Middle East
Construction Exhibition,
Jeddah Expo Centre
15-21 January 1981
10am-1pm and 5pm-10pm

جاسم السليمان

Narrow win for Pakistan

Spain takes point off Holland

By Shahid Orakzi Arab News Correspondent

KARACHI, Jan. 14 — Pakistan, two-time winners of the Champions' Trophy, had a narrow, lack-lustre 3-2 victory over surprisingly plucky England here Wednesday. The world champions already beaten by Holland and Australia, can now at best hope for a third position in this six-nation field hockey championship.

Munzoor Jr and Jan Muhammad replacing left-in Hanif at the half-time.

Pakistan, who led 2-0 at interval got their first goal through a penalty corner in 16th minute. Left-full-back Naseer was brought to strike after Ehsanullah wasted four earlier opportunities. Two minutes before interval a solo effort by right in Mushtaq earned Pakistan a penalty-stroke, easily converted by Kalimullah. Mushtaq dodged all defenders but a flick by him was stopped by England's right half with his foot.

After breather England put pressure and earned a few short and long corners, but custodian Qamar Zia confidently foiled the attempts. England reduced the lead through Hughes but minutes later Nasir Naseer struck again of a penalty-corner. Pakistani defenders were later penalized for blocking England forwards and West Coat converted the penalty stroke.

Attacks by Pakistani forwards cracked the England defence a number of times and on one occasion a flick by spearhead Iqbal hit the bar.

In a thrilling encounter, Spain held Holland to a 3-3 draw. The Dutch who are favorites for the trophy now have six points from their four matches, two victories and two draws. But the performance by low-rated Spaniards could go to the advantage of super-fit Germans who are second on the table.

West Germany, however, has still two difficult matches to play. They meet Australia Thursday and then Pakistan whom they lost 4-3 in last year's final.

A large crowd cheered the Spanish team as they fought back for an equalizer. Right-full-back Coghén struck twice in the two halves. Dutch gained the lead in sixth minute when a shot by Ties Kurize was deflected by Hiens, but four minutes later the Spaniards equalized of a penalty-corner.

Most of the Game was played in mid-field but there were thrilling moves in the closing moments. Dutch went into the lead, 3-2, through Paul Litgens four minutes before final whistle. But even in that the Spaniards didn't lose heart. On a corner combination, Rouka found the top of the net. The draw, almost a win for Spain, had resulted from their superior defence which checked Paul Litgens capabilities.

Chris Evert honored

In World Special Slalom

Stenmark finishes second

WEST GERMANY, Jan. 14 (AFP) — Swedish skiing superstar Ingemar Stenmark continued to be far less than perfect this season, placing second Tuesday to Paul Frommelt of Liechtenstein in the World Cup Special Slalom.

The double olympic gold medal winner lost only one hundredth of a second. But this slim margin, plus his disqualifications for shooting off the special Slalom course at Sarvisch-Partenkirche and falling in the Slalom at Ebnat-Kappel (Switzerland) leaves grist to talk that Stenmark is now on the decline.

Frommelt won with a fast first-leg time of 55.06 seconds, with Stenmark the fourth fastest (55.37). Stenmark was the fastest on the second-leg (49.06), but it just wasn't enough. Frommelt excelled on the flat, final section while "Ingo" was left complaining that "the course was poorly prepared and that it was more difficult than I had expected."

In Schruns, the Swiss kept coming as 19-year-old Rika Hess notched her first World Cup victory with a win in the Women's Special Slalom. Fellow Swiss Doris de Agostini won the Downhill Monday.

Hess was far after the first-leg but outsped the rest of the field on the steep, fogged-in trail by more than a second and a half in the second-leg.

The last Swiss to win a Women's Special was Lise-Marie Morerod at Badgastein 1978. It was a bright day for the Americans, Tamara McKinney placed third and Christine Cooperan sixth.

Pate triumphs

PALM SPRINGS, Jan. 14 (AP) — Jerry Pate fired a tournament and course record 63 Tuesday to capture the 10th annual Howard Josell Day with the all-Americans Golf tournament at Canyon Country Club. Pate carded eight birdies and 10 pars over the 6,600-yard, par-71 south course at Canyon. Rookie pro Bob Clampett finished second with a 66, followed by veteran Gay Brewer at 67. Seven golfers Alan Tapie, Curtis Strange, Mike Ried, Bob Murphy, Danny Edwards, Bill and Nancy Coules and Tim Norris all at 68.

Argentine Grand Prix postponed again

BUENOS AIRES, Jan. 14 (AP) — The Argentine Grand Prix Formula One auto race has been rescheduled for April 26, set for the Argentine Automobile Club president Cesar Carman said Tuesday. Carman said the decision to change the date of the race, originally set for Feb. 22, was the result of an agreement between the club, which organizes the competition, and the International Motor Sport Federation. The club president declined to explain the reasons for the rescheduling of the Argentine race which, in previous years, has been held in January as the season opener for the World Formula One Championship.

Steve Docherty gives Tanner a fright

PORTLAND, Oregon, Jan. 14 (AP) — Roscoe Tanner, the favorite of the Louisiana-Pacific Indoor Tennis Tournament, had to go into a tie-breaking fourth set to avoid being eliminated in the opening round Tuesday.

The Santa Barbara, California, player beat Steve Docherty of Portland 6-3 then lost 4-6 and tied 6-6 before winning 7-5 in the tie breaker. Tanner trailed 5-4 in the tie breaker before overcoming the Portland pro.

Defending champion Bruce Manson of Dallas, Texas, lost to Billy Martin of Los Angeles 7-6, 7-5. International junior champion Sammy Giammalva, a student at Southern Methodist University in Dallas, beat Blain Willenborg of Los Angeles 6-1, 6-1. Other first-round winners were Ben Tes-

terman of Knoxville, Tennessee, John Austin of Los Angeles and Pat Dupre of LaJolla, California.

In New York, Sweden's Bjorn Borg and American John McEnroe, the world's top two tennis players, could meet twice in five days at Madison Square Garden. The two young maestros are in the same four-man group in this annual event which brings together the top eight players on the circuit. Their first meeting will be on Thursday and regardless of the outcome of that match both players are expected to qualify for the semi-finals on Saturday. They could then go through to Sunday's final for the \$ 100,000 top prize.

Borg and McEnroe are in the tournament's Blue group along with Jose-Luis Clerc of Argentina and Gene Mayer of the United States, two newcomers in the event who can be expected to find the challenge of their celebrated rivals too much for them.

The Red group is made up of Americans Jimmy Connors, the 1978 Masters champion, and Harold Solomon, Argentina's Guillermo Vilas and 20-year-old Ivan Lendl.

Borg beat McEnroe three times in four classic encounters in 1980, including the memorable five-set Wimbledon final, but the 21-year-old American has beaten the Swede four times, three of his victories having been recorded on indoor surfaces similar to the medium-speed carpet on which the masters is played.



TWO AGAINST ONE: Paul Mariner, who got Ipswich's third goal, tries to make his way past Arsenal defenders in an earlier match.

To regain top berth

Ipswich trounces Birmingham City

IPSWICH, England, Jan. 14 (AP) — Ipswich Town surged back in style to the top of the standings in the English Division Tuesday night thrashing Birmingham City 5-1 on a snow-covered Portman Road pitch.

Ipswich, the bookmakers' favorite in what many believe is a three-horse race for the title with rivals Aston Villa and Liverpool, took the lead after just 10 minutes when John

Wark scored his 24th goal of the season in League and Cup games.

Center back Terry Butcher and England striker Paul Mariner added two more goals before half-time, sandwiched either side of one by Birmingham's Frank Worthington. Dutchman Arnold Muhren and Scotsman Alzn Brazil finished off Birmingham in the second half.

Ipswich, which had chances to score even more goals in its quest for a title that could well be decided on goal difference, displaced Aston Villa as league leaders. Villa itself had gone top after an impressive 2-0 win over Liverpool Saturday.

Ipswich looked to be in the best position of the three, with 37 points from 25 games. Villa had 26 points and Liverpool 34, but both have played one game more than Ipswich.

The English Football League Cup semi-final first-leg match between Coventry and West Ham has been postponed because West Ham are playing Wrexham in an F.A. Cup

Murata keeps crown

TOKYO, Jan. 14 (AP) — Champion Eijiro Murata of Japan defended his Oriental-Pacific bantamweight title Tuesday by knocking out Lee Chong Soo of South Korea in the eighth round of a scheduled 12-round title bout. The knockout came at 58 seconds of the eighth round when Murata's right hook landed on Lee's jaw. Murata scored the first knockdown over Lee in the seventh round.

It was Murata's sixth defense of the Oriental-Pacific title he won from Yungshik Kim of South Korea by a unanimous decision Dec. 14, 1978.

third round second replay Wednesday night. Meanwhile, it seems unlikely that Johan Cruyff will be offered an inflated salary to sign for Chelsea. The Dutch international will have talks with Chelsea financial director Martin Spencer after guesting for DS 79 in a friendly at Stamford Bridge Wednesday night.

Gould Magooli clear said: "Mr. Spencer knows the wage structure of this club and he also knows the feelings of Geoff Hurst and myself about Cruyff." "We don't feel that the wage structure should be broken for anybody — we are very strong about that. It could be unsettling for other players and that is the last thing we want."

PENTAX advertisement featuring a camera image and the name SHAMSUDDIN ASHRAF.

Gulf Regional Bureau

The Saudi Research and Marketing Company, publishers of Arab News, Asharq Al Awsat, Al Majallah, Saudi Business and other publications, has opened an office in Bahrain to cover the events of the whole Gulf region.

Address: P.O. Box No. 20534, Bahrain Tower Bldg Manama, Bahrain Telephone 232328

RENAULT ALPINE A310

"THE DESERT-FOX" An exciting sports-car with a powerful engine in a "luxury design". Documents available by: Ricken-Garage Hurlimann Bros. Tel. 074-72152 9630 Wattwil, Switzerland Tel: direct 00541 - 7472152

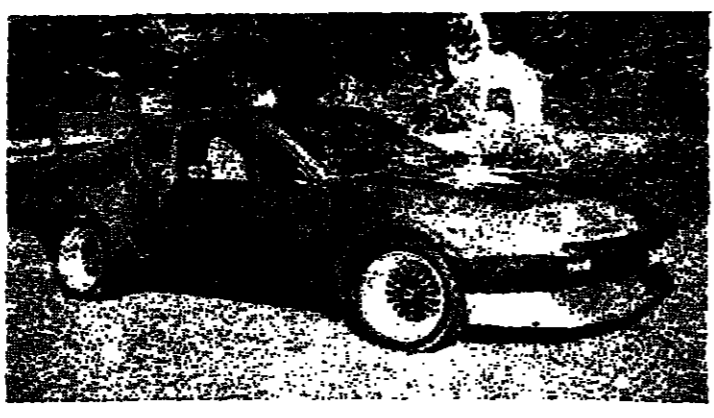

AL BANDAR AUTOMOTIVE

ANNOUNCES SPECIAL SALE OF

PIRELLI TYRES & TUBES

With Discount From 10% UP TO 20%

ON ALL THEIR RADIAL AND NYLON LINES. ONLY FOR 15 DAYS. STARTING THE 10TH OF JANUARY 1981.



DIRECTLY FROM OUR STORES IN JEDDAH, PALESTINE ROAD.

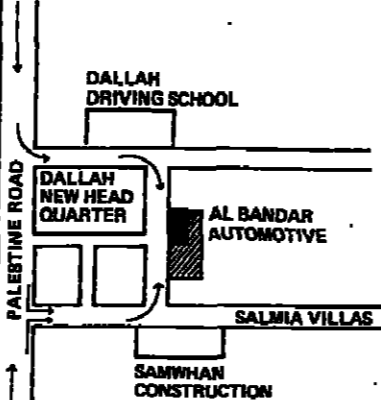

TO MECCA NEW MECCA - MEDINA ROAD TO MEDINA

Houston is a Saudi Research & Marketing Town

There's hardly an industry in Houston that isn't directly or indirectly involved in the Arab Middle East. And that's why Houston is a Saudi Research & Marketing town.

We offer a full range of Arabic marketing services, including Arabic translation and typesetting, original Arabic calligraphy, graphic design and print and audio visual production.

What sets us apart from other communications companies is our ability to function in two markets at the same time. Our bilingual, bicultural communications team consists of Saudi and American media specialists who understand and appreciate the Saudi Arabian taste, lifestyle, culture and religion.

Whether you need Arabic English brochures, identity programs, advertisements, proposals, cultural orientation programs, motion films, slide shows, total marketing plans or finished presentations, we deliver.

- Arabic Translation & Typesetting • Original Arabic Calligraphy • Graphic Design • Print & Audio Visual Production • Cultural Orientation & Training



SAUDI RESEARCH & MARKETING, INC. 2100 West Loop South, Suite 1650 Houston, Texas 77027 (713) 961-0245

The leader in publishing and communications since 1947

BEETLE BAILEY



BLONDIE



B.C.

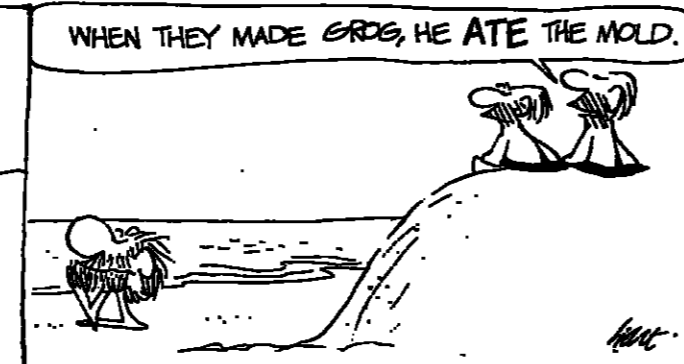

ANDY CAPP

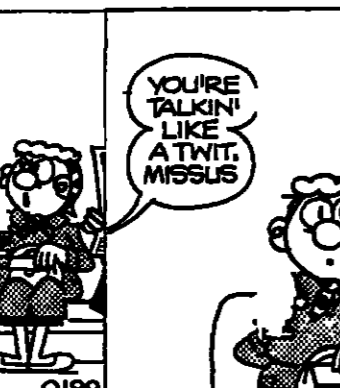

HAGAR



SMALL SOCIETY



WIZARD

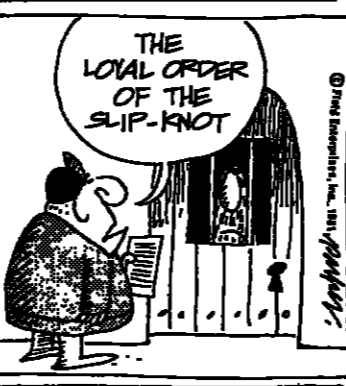

ARAB NEWS CALENDAR

DHAHRAN TV

Table with 2 columns: Time and Program Name. Includes Children's Show, Soccer, Soap, etc.

VOA

Table with 2 columns: Time and Program Name. Includes News Roundup, News Summary, etc.

PHARMACIES

Table with 3 columns: Pharmacy Name, Address, and Phone Number.

SAUDI RADIO

On FM at 98 Megahertz to 3.3 meter band. On SW at 11.855 MHz in 25 meter band.

Table with 2 columns: Time and Program Name. Includes News Summary, Sports, etc.

BBC

Table with 2 columns: Time and Program Name. Includes World News, Sports, etc.

DENNIS the MENACE

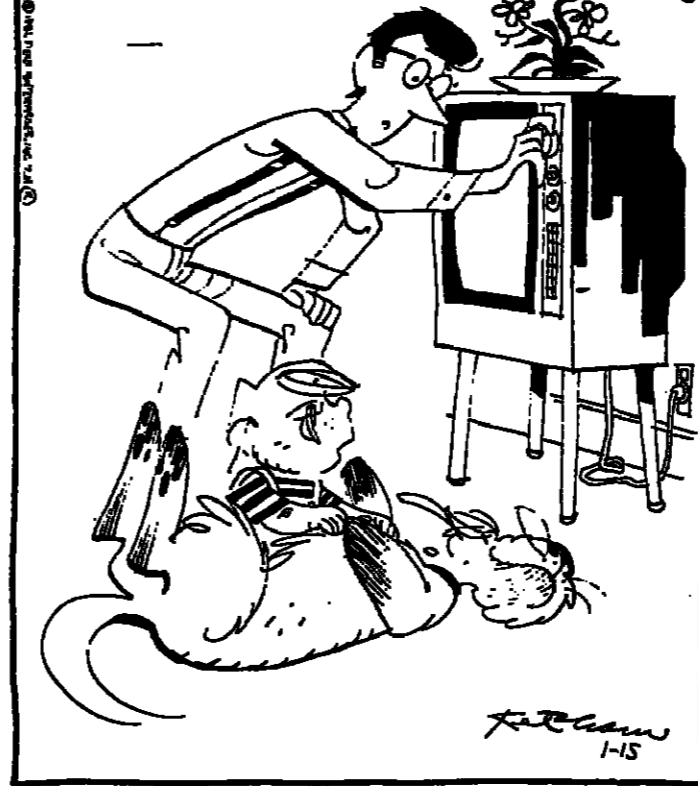

'I WAS WONDERIN'... IF OL' RUFF CAUGHT THE MEASLES. HOW WOULD WE KNOW IT?'

Contract Bridge B. Jay Becker

Beyond the Shadow of a Doubt

South dealer. Both sides vulnerable. NORTH ♠A Q 8 4 ♡9 7 2 ♢K Q 6 5 ♣Q 8. EAST ♠10 6 3 ♡J 5 3 ♢8 4 2 ♣10 9 7 4.

The bidding: South 1♣ West Pass North 3♣ East Pass. Opening lead - ten of diamonds. The careful dummy player does not relax merely because he sees there is an excellent chance for the contract.

©1981 King Features Syndicate, Inc.

Your Individual Horoscope

Frances Drake FOR THURSDAY, JANUARY 15, 1981

What kind of day will tomorrow be? To find out what the stars say, read the forecast given for your birth sign. ARIES (Mar. 21 to Apr. 19) Despite present financial limitations, a talk with a higher-up looks promising.

Crossword by THOMAS JOSEPH

Crossword grid with clues for Across and Down.

Yesterday's Answer: 22 Navigate in a way, 23 Pilot's path, 24 Of love, 25 Traitor, 27 Throng, 29 Devoutness, 30 Miscalculation, 31 He played Superman, 32 Arab republic, 34 In the center, 37 Eye.

Believe It or Not!

Advertisement for Benito Mussolini featuring a portrait and text: 'THE ITALIAN DICTATOR WROTE A SUCCESSFUL PLAY THAT WAS PRODUCED IN THE 1930S IN VIENNA, LONDON, ROME, GERMANY AND PARIS'.

DAILY CRYPTOQUOTE - Here's how to work it: AXYDLBAXE & LONGFELLOW

One letter simply stands for another. In this sample A is used for the three L's, X for the two O's, etc. Single letters, apostrophes, the length and formation of the words are all hints. Each day the code letters are different.

STAN SMITH'S TENNIS CLASS

Advertisement for tennis class: 'DEUCE COURT SERVICE STRATEGY IN SINGLES HIT MOST SERVES DOWN THE MIDDLE... TO YOUR (RIGHT-HANDED) OPPONENT'S BACKHAND. WIDE SERVES OPEN UP COURT TOO MUCH.'

IN DOUBLES

Advertisement for tennis doubles: 'SERVE WIDE MORE OFTEN... YOUR PARTNER AT NET PROTECTS OPEN SIDE (SPECIALLY IF YOU TIP HIM OFF BEFORE SERVING)!!'

FOR INFORMATION

DRAVO ARABIA LTD. wishes to advise all companies and persons in the Kingdom of Saudi Arabia that their employee **MR. GRAHAM A. WILLIAMS**, of British nationality, passport No. H 010805, departed the Kingdom on 25th October 1980 on an Exit/re-entry visa. He has not returned to his work as scheduled and the company does not accept responsibility for the actions of this person during the validity of the re-entry visa.



ANNOUNCEMENT

The Modern Trading & Contracting Co. (MOTACO), announces that **Mr. Afeef Hamra** (Lebanese, passport 145848) is leaving the kingdom on an Exit-Visa only. Anybody who has claims against him should contact the company within seven days of this Notice.
Phone 4645161 - 4650090
P. O. Box 9608

REQUIRED

EXPERIENCED SALESMAN AND SALES SUPERVISOR specialised in Telephone and Power Cables required to work with American Organisation in Riyadh. Must speak, read and write English fluently. Knowledge of Arabic language will be helpful. Persons interested with transferable Iqama, should forward C.V. to:

MR. SHAH A SALJAD
United Technologies Saudi Arabia Limited
P.O. Box 11, Riyadh.

FOR SALE

GOOD 20 FT AND 40 FT CONTAINERS. DELIVERED TO SITE ANYWHERE IN THE KINGDOM.
FOR FURTHER INFORMATION CONTACT **TONY WILKINSON** ON RIYADH 4645201/4645202.

Clinique Des Charmettes

Gynaecology	Surgery of Digestive Tracts	Internal Medicine
Obstetrics	Urology	Check-up; Dietetic Or
Nursery	Neurosurgery	Endocrinology
Ophthalmology	Cardiology	Treatment of very severe burns
General Surgery	Dialysis	
Orthopaedics		

Cosmetic and Plastic Surgery
Laboratories — Radiology — Physiotherapy
Echographia — Convalescence

Close collaboration with University hospitals.
The clinic offers a first class, permanent medical service, in a very pleasant and agreeable atmosphere.
Excellent food with Arabic specialities.
Arranged airport meeting by nurse and hostess.

1003 LAUSANNE (SWITZERLAND)
Chemin de Mornex 6 and 10
Tel. 021/20.41.31 (5 Lines) Telex: 24851 fidax - ch

OUR BUSINESS IS GLASS

WIDE RANGE EX-STOCK
QUALITY PRODUCTS
MODERN MACHINES
SKILLED PERSONNEL
RELIABILITY

INDECOM
P.O. Box 2838, Jeddah
Tel: 6824931
Tlx: 401126 JEDDAH

ELECTRICAL CABLES

West European Quality.
Large Quantities Ex-Stock.
Competitive Prices.

Call Mr. Gaspard
INDECOM — P.O. Box: 2838, Jeddah
Tel: 6824931, Telex: 401126

JABRIA جابرية

JABRIA EST. SAUDI & ITALIAN CONTRACTORS

- MULTISTORY BUILDINGS
- RESIDENTIAL COMPLEXES
- FACTORIES
- ARMCO STEEL STRUCTURES

TELEPHONE: 4761707 - RIYADH SAUDI ARABIA

PETBOW GENERATORS
CAPACITY FROM 5 TO 1000 K.V.a.

STOCK AVAILABLE AT **EXPRESS CONTRACTING & TRADING**

Petbow

Jeddah P.O. Box 2951 Tel 6829454 - 6829464 Telex: 401082 SINDC
Riyadh P.O. Box 3758 Tel 4044172 Telex: 201512 SINDCO
Al Khobar, P.O. Box 1450 Tel 8645113 - 8645109 Telex: 871433 SINICO

HASSELBLAD

Great ideas last for ever

Sole Agent
SHAMSUDDIN ASHRAF
P.O. Box 285 Al Khobar, Saudi Arabia. Tel: 8641104. Cable: ASHRAF'S.
Riyadh - Tel: 4025258. Jeddah - Tel: 6439664/ 674796.

YOUR FAST WAY TO YOUR BETTER JOB, BETTER PAY!

WITH YOUR AIRSPEEDED ICS HOME STUDY COURSE

Study where and when you like, at your own pace. Choose from over 500 courses! World renowned personal ICS tuition by fast airspeeded post Pass the top internationally recognised exams — get your better job, better pay!

For Free Details Underline Your Subject of Interest Below

BUSINESS • GCE • TECHNICAL ACCOUNTANCY • ELECTRONICS FIRE SERVICES • LEISURE AGRICULTURE

Name _____
Address _____

Fill in your name & address, cut out the whole advertisement and return it to

ICS INTERNATIONAL CORRESPONDENCE SCHOOLS
DEPT. 601 STEWARTS ROAD, LONDON SW8 4UJ UNITED KINGDOM

For the attention of our clients

DO YOU HAVE PERSONAL EFFECTS/CARS/CARGO FOR SHIPMENT DAMMAM/KARACHI?

WE — AGENTS FOR THE PAKISTAN NATIONAL SHIPPING CORPORATION — ARE PLEASED TO ANNOUNCE THAT: WE HAVE NOW

M.V. ZIARAT

WHICH IS REGULARLY CALLING BETWEEN KARACHI/DAMMAM FORTNIGHTLY.

BESIDES, WE CAN ALSO ACCEPT YOUR CARGO ON OTHER P.N.S.C. VESSELS CALLING DAMMAM REGULARLY.

FOR ANY FURTHER INFORMATION, PLEASE CONTACT US:

M/S. SOUTH-EAST ASIA SHIPPING AGENCIES
P.O. BOX 477 — DAMMAM
PHONES: 8323689 - 8322866 - 8323809
TELEX: 601053 - 601453

OUR OFFICE IS LOCATED NEAR DAMMAM OBEROI HOTEL.

International Business Opportunities

WE ARE LOOKING FOR DISTRIBUTORS, FRANCISERS OR INDEPENDENT BUSINESSMEN WHO ARE INTERESTED IN NEW BUSINESS OPPORTUNITIES IN THE FIELDS OF:

- AUTO REPAIR SHOPS
- CAR WASH CENTRES
- AIR CONDITIONING REPAIR SHOPS
- VOCATIONAL TRAINING
- FAST FOOD OUTLETS
- QUICK PRINTING SHOPS
- LAUNDRY AND DRYCLEANING
- CONSTRUCTION MATERIAL SHOPS
- MICRO COMPUTER SHOPS
- MANAGEMENT CONSULTANTS AGENCIES

FOR DETAILS WRITE TO CANADIAN MANAGEMENT CONSULTANTS, 1867 YONGE STREET, SUITE 600, TORONTO, ONTARIO, M4S 1Y5 CANADA.

ATCO SAUDI ARABIA LTD.

DUE TO CONSOLIDATION OF OUR OPERATIONS TO DAMMAM, WE HAVE THE FOLLOWING AVAILABLE FOR LEASE & SALE IN JEDDAH.

FOR LEASE

20000 M2 GOOD LEVEL, FENCED LAND C/W ONE TELEX AND TWO TELEPHONE LINES IN SERVICE.

FOR SALE

SEPERATELY OR IN CONJUNCTION WITH THE LAND LEASE ARE THE FOLLOWING

ONE 180M2 ATCO OFFICE FULLY EQUIPPED AND INCORPORATING ABOVE TELEX & TELEPHONE FACILITIES.

TWO MDL. D346 CAT GENERATORS 275 KVA EACH C/W AUTOMATIC START/STOP & LOAD SHARING CONTROL PANELS + FUEL TANK & BUILDING.

ONE ATCO 13 BEDROOM MGM. COMPLEX C/W INDIVIDUAL SHOWER/TOILET + COMMON LAUNDRY & RECREATION FACILITIES.

CONTACT:
MR. R. ATTARI OR MR. S. DESILVA
AT JEDDAH 826292 — 820280.

ATCO ALSO HAVE A REQUIREMENT FOR 50 SKILLED TRADESMEN, ELECTRICIANS, PLUMBERS, CARPENTERS FOR A SEVEN WEEK PROJECT IN TABUK, IMMEDIATE START.

REPUTABLE COMPANIES INTERESTED IN THIS PROJECT SHOULD CONTACT **MR. GEO J. BROWN** AT DAMMAM 8647393

ANNOUNCEMENT

PILOT **BRIAN A. DEAN** AMERICAN NATIONALITY WHO IS UNDER THE SPONSORSHIP OF **AWAIDA**, WAS GIVEN TWO MONTHS EXIT AND RENTRY VISA, AND ACCORDING TO THE EXPIRATION OF HIS VISA WITHOUT HIS RETURN TO HIS JOB. ANY ONE KNOWS ABOUT HIM IS KINDLY REQUESTED TO CONTACT.

TEL. NO. 4771312 AWAIDA IS WARNING EVERY BODY DEALS WITH OR HIDING HIM.

NEEDED

SECOND HAND

1 CRAWLER CRANE MANITOWAC - 3900

1 CRAWLER CRANE MANITOWAC - 4100

IN GOOD WORKING CONDITION

ballast nedom

PLEASE CONTACT:
MR. J. P. TEN SJTHOFF
Plant Manager
AL-HARTY BUILDING
AIRPORT ROAD, RIYADH
TEL. 4010070

